

 **F-Line[®].PRO**

AIR DISTRIBUTION NETWORK

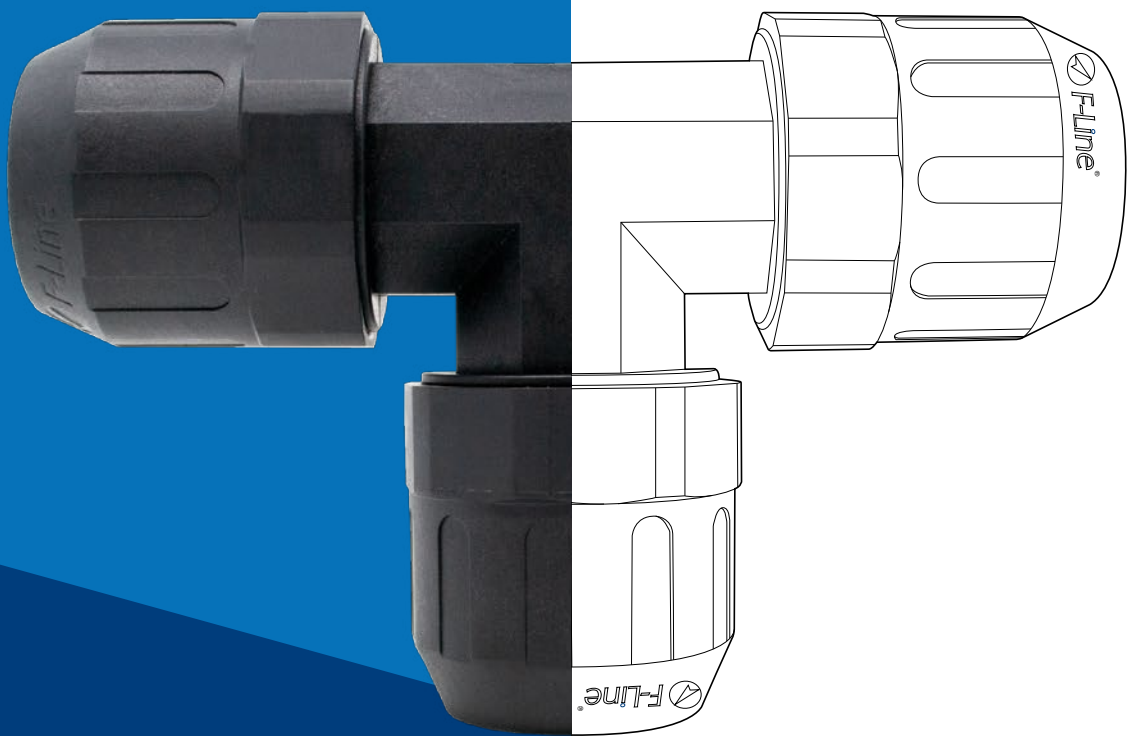

25
anniversary

 **TierreGroup[®]**
Unique vision

 *F-Line*[®].PRO

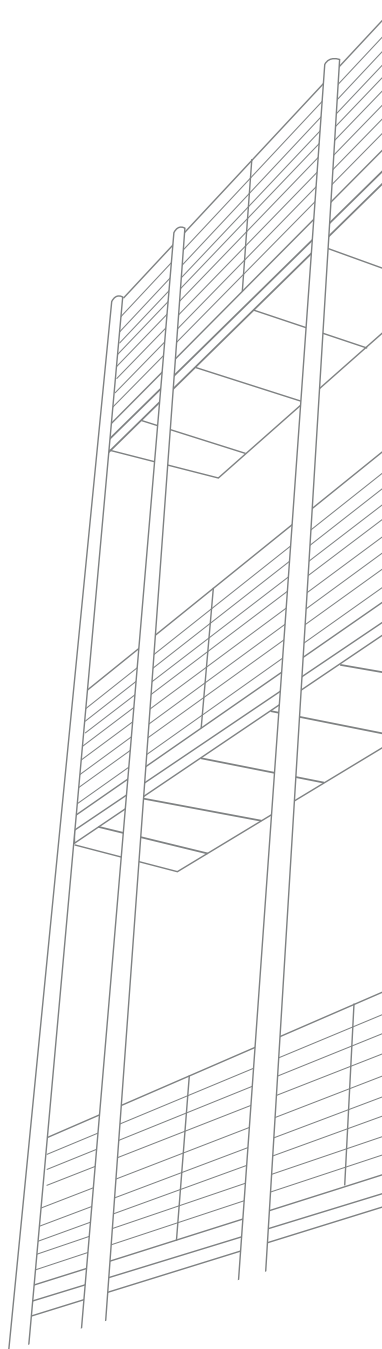

 **TierreGroup**®

 **TierreFittings**®

 **F-Line.PRO**

 **NET.Fit**

 **INOX.Fit**



 **F-Line[®].PRO****PLUS**

Strong construction and rated up to **16 BAR**

LIGHTWEIGHT AND SUITABLE FOR OVERHEAD INSTALLATIONS

Simple and fast installation time due to the **INTEGRATED PUSH-IN SYSTEM**

LAYOUT MODIFICATION SYSTEM

VISIBLE INDICATOR WHEN FITTING NUT IS FULLY TIGHTENED

DOUBLE PROFILE SEALS BEFORE GRIPPING CLAW DESIGN, to prevent tube scratches and avoid leaks

REINFORCED PA MATERIAL



RIGID TUBES



p. 18 / **FPAL-4AZ**



p. 18 / **FPAL-6AZ**



p. 19 / **FPAL-6GR**



p. 19 / **FPAL-6VD**



p. 19 / **F-IS**

BRACKETS



p. 20 / **FPST**



p. 20 / **FPDST**



p. 20 / **FPCL**



p. 20 / **FPAN**



p. 21 / **FPMT**



p. 21 / **FPMP**



p. 21 / **FPMRS**

FLEXIBLE TUBES



p. 22 / **FPTUC**



p. 23 / **FPTUX**



FITTINGS

Male BSPT
thread connector



p. 25 / **FPK**

Male BSPT
thread connector
aluminum body



p. 25 / **FPCA**

Union connector



p. 25 / **FPUC**

Reduced
union connector



p. 25 / **FPG**

Union elbow



p. 26 / **FPUL**

Union elbow 135°



p. 26 / **FPULH**

Union tee



p. 26 / **FPUT**

Reduced
union tee



p. 26 / **FPGT**

Female tee



p. 27 / **FPGT-G**

End plug



p. 27 / **FPPF**

Quick branch



p. 27 / **FPBR**

Quick branch
BSPP thread



p. 27 / **FPBR-G**

WALL APPLIQUES

Single applique
stainless steel
AISI 316L



p. 28 / **FPSAS**

Double applique
stainless steel
AISI 316L



p. 28 / **FPDAS**

Single applique
aluminum



p. 28 / **FPWLM1**

Double applique
aluminum



p. 28 / **FPWLM2**

VALVES



p. 30 / **9210PRO**



p. 30 / **9220PRO**



p. 31 / **9120F**



p. 31 / **9611**



p. 31 / **9210**



p. 31 / **9220**



p. 31 / **9250**



p. 32 / **1610**



p. 32 / **1110**



p. 32 / **1112**



INSTALLATION ACCESSORIES



p. 33 / **FPTD**



p. 33 / **FPCH**



p. 33 / **FPTT**



p. 33 / **FPUS**



p. 34 / **FPHBT**



p. 34 / **R-PTFE-PROF**



p. 34 / **LOX1810**

QUICK COUPLINGS

UNIVERSAL SERIES



p. 36 / **QUICK COUPLING**



p. 38 / **ITALY PROFILE**



p. 40 / **GERMANY PROFILE**



p. 42 / **ISO 6150-B12 (USA) PROFILE**



p. 44 / **SWISS PROFILE**

FLUID-10 SERIES



p. 46 / **FLUID-10N**



p. 48 / **FLUID-10S SAFETY**

EUROSTANDARD SERIES



p. 52 / **EU-75N**



p. 54 / **EU-75S SAFETY**

TECHNICAL & COILED TUBES



p. 58 / **PU-PVC**



p. 59 / **PVC-AC**



p. 60 / **UCES**



p. 62 / **UCES-G**



TECHNICAL SPECIFICATIONS

The F-Line.PRO system has been designed for the realization of networks for compressed air, vacuum, neutral gases and for the construction of industrial plants. Thanks to the very long experience in the industrial field, with focus on pneumatic applications, Tierre Group created a new system, highly technological. F-Line.PRO is a quick assembly system with a perfect pneumatic seal and a remarkable mechanical endurance. The special aluminium alloy of the pipes, coated by hot electrostatic paint, and the high performance reinforced polymer used for the fittings are the best solution for compressed air networks and minimize the risk of corrosion, always granting the best possible quality of the air for a long life of the system and of the connected tools in normal working conditions. Easy to be assembled, thanks to the low weight components (tubes, fittings and accessories), connection without glue or welding needs, reusable, modular, these are only some of the advantages when choosing F-Line.PRO.

PLANT DESIGN

Here below you will find some tables and technical details to be considered as suggestions for the design of an efficient network. We suggest, when possible, to create networks through a closed ring. This solution will equilibrate the flow and will work as an air storage, keeping a stable air pressure. Moreover, a closed air ring is the best solution in case of maintenance and modifications, avoiding the need of a complete stop of the system. In order to reduce shocks and vibrations, we recommend you to use FPTUC tubes (see page 20) for connecting the network to the air compressor.

COMPRESSOR'S INDICATIVE AIR DELIVERY (AT 7 BAR)

KW	1,5	3	4	5,5	7,5	11	12,5	15	18	22	29	37	45	55
CV	2	4	6	7,5	10	15	17	20	25	30	40	50	60	75
NI/min	230	400	600	900	1200	1750	2000	2500	3000	3500	4500	5500	7000	8500

PLANT SIZING

According to the distance from the compressor to the most distant user and to the required flow, this table let you calculate the best F-Line.PRO diameter for your network, taking in consideration that the values refer to a closed ring at a pressure of 8 bar with a maximum pressure loss of 5%.

		METERS								
Nm ³ /h	NI/min	25	50	100	150	200	300	400	500	1000
36	600	20	20	20	20	25	25	25	25	40
54	900	20	20	20	25	25	25	40	40	40
72	1200	20	25	25	25	40	40	40	40	40
105	1750	25	25	40	40	40	40	40	40	
150	2500	25	40	40	40	40	40	40		
210	3500	40	40	40	40	40				
270	4500	40	40	40	40					
360	6000	40	40	40						
510	8500	40	40							



FLOW DROPS FITTINGS TABLE

This table is an another useful help in order to get a right plant dimensioning. Each fitting determines a loss of charge and the table indicates the correspondence to pipe meters for every assembled fitting. The equivalent length obtained from all fittings will be added to the average length of the installed pipe.

SIZES	FITTINGS TYPES						
	FPC FPCA	FPUC	FPUL	FPUT	FPGT	FPBR	FPWLM
20	0,2	0,2	1,2	0,2	-	-	-
25	0,2	0,2	2	0,3	1,8	2	4
40	0,3	0,3	3,6	0,4	3,5	4	-



THERMAL EXPANSIONS

It's important to check the dimensional changes due to temperature variations in order to avoid that the expansional contraction effects may cause heavy damages to the plant; for that reason it's necessary to sustain and bracket the plant in order to let the pipeline free slide between two fixed points or otherwise to insert a compensator between two fixed points if they are positioned at a distance which may cause sensible contractions/expansions.

For the system F-Line.PRO with aluminum tube this coefficient "d" is equal to 0,023 mm/m/°C.

Aluminum thermal expansion factor: 0,023 mm/m/°C

CONTRACTION - EXPANSION OF ALUMINUM TUBE

L (m)	T MIN	T MAX	ΔT	ΔL
10	5°C	45°C	40	9,2 mm
20	5°C	45°C	40	18,4 mm
30	5°C	45°C	40	27,6 mm
50	5°C	45°C	40	46 mm
100	5°C	45°C	40	92 mm

Table of contraction - expansion depending on the length **L** of a straight stretch and the temperature difference **ΔT**.

The design and the construction of any plant will consider this phenomenon which is calculated with the following formula:

$$\Delta L = d \times L \times \Delta T$$

LEGEND:

d= coefficient of lateral expansion

L= length of piping

ΔT= difference of temperature in centigrade

ΔL= difference of length (expansion or contraction)

example: temperature is +10°C; length of piping 20m; working temperature 35°C

$$\Delta T = 35 - 10 = 25^\circ \text{C}$$

$$\Delta L = 0,023 \times 20 \times 25 = 11,5 \text{ mm}$$



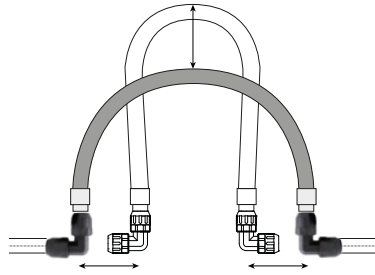

DN	FLEXIBLE TUBE LENGHT
25	1 m / 2 m
40	1,5 m / 3 m

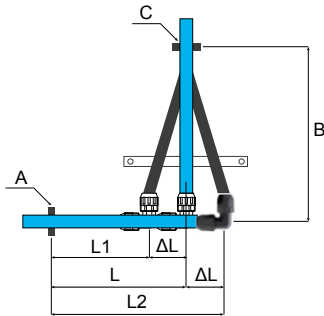

- L:** pipeline length at the installation
- L1:** length with minimum temperature
- L2:** length with maximum temperature
- ΔL:** length difference due to ΔT
- B:** length of the arms of the Lira or of the direction change
- A:** Sliding bracketing
- C:** Fixed bracketing

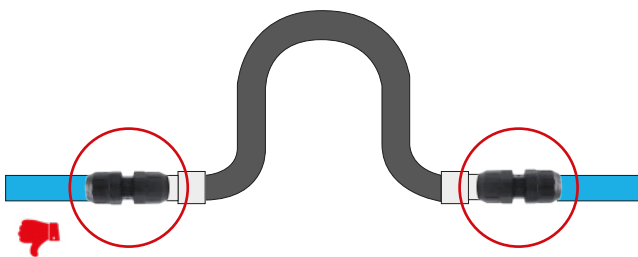

Avoid anchoring the expansion joint to two connections aligned to the same plan.

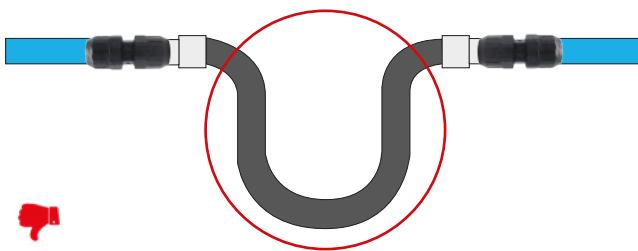

Always install the expansion joint facing upwards and not downwards in order to avoid a deposit of the condensation.

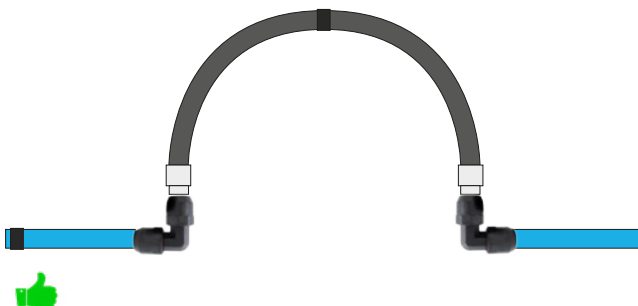

This is the correct application of the installation of expansion joint. It should be facing up and with two elbows aligned. You need also to insert two clips on the pipe aluminum fasteners close to the installation of an expansion joint.



ASSEMBLY & DISASSEMBLY INSTRUCTIONS

Mod I82 - rev.1 01/2022

F-Line.PRO system has been studied and realized in order to obtain an easy, fast and safe installation.

These assembly and disassembly instructions are intended for the installer / maintainer of the F-Line.PRO system. They intend to provide a support tool for correct installation, in order to provide the best possible product performances and avoid accidents during installation and subsequent use of the system.

Any use other than the construction of a compressed air, vacuum and neutral gases networks must be considered improper and, therefore, not allowed. Improper use exempts Tierre Group S.p.a. from any liability for any damage to persons or properties. Failure to comply with the conditions of use and these instructions automatically invalidates any type of warranty.

The installation, repair and maintenance operations must be carried out by suitable and qualified people and must be carried out in full compliance with the reference standards for the safety of people. The installer is responsible for everything concerning the safety of the installed products.

ASSEMBLY INSTRUCTIONS



Always use the personal protective equipment required by the regulations. In particular, it is recommended to use protective gloves that allow a firm grip and that are able, at the same time, to prevent any injuries.



It is recommended to provide one or more drainage points for any condensation. The drainage points must be made at the lowest points of the main pipeline by using Tee fittings.



Prepare the tube for assembly. If necessary, cut the pipe using the appropriate FPTT tool. The pipe cut must be perpendicular to its axis (90 ° cut).



Always deburr the pipe, externally and internally, eliminating sharp edges, before making the connection with the fittings. Use the FPUS accessory.



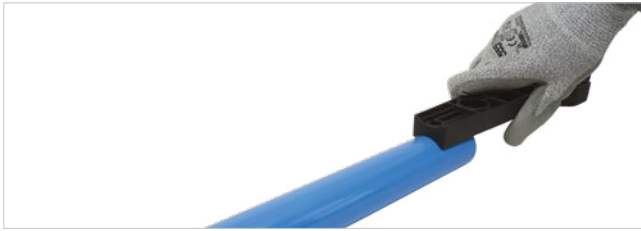

Mark the pipe using the caliper located on the handle of the appropriate tightening wrench (FPCH) in order to identify the correct and complete insertion of the pipe into the fitting.



The F-Line.PRO system is a push-in system. Insert the pipe into the fitting **WITHOUT** unscrewing the nut (check that the fitting has been supplied with a completely screwed nut before connection: the screwing witness must not be visible). In order to facilitate insertion, center the tube with respect to the gasket and, subsequently, carry out the complete insertion.

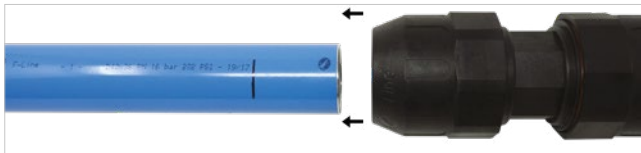

Check the correct insertion by checking the marking previously made on the pipe with respect to the insertion of the nut (the sign must be near the end of the nut).



It is recommended to carry out a preventive test of the system or section before starting to use it.



DISASSEMBLY INSTRUCTIONS

It is recommended to check that the system is off and that there is no residual pressure in before carrying out any disconnection.



Use the dedicated FPC keys for the unscrewing operations. Never use unsuitable tools that could compromise or damage the fittings (eg multigrip pliers). The use of work gloves is recommended.



Unscrew the nut until the screwing witness is completely visible. Be careful not to insert the tube into the fitting during this step.

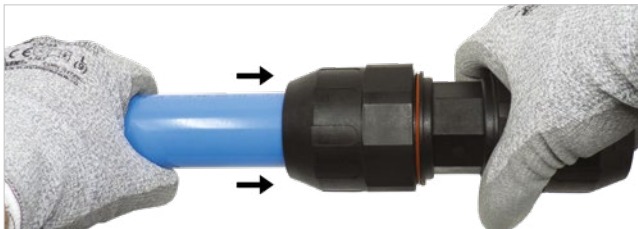

Push the tube slightly towards the fitting until the locking ring is disarmed.

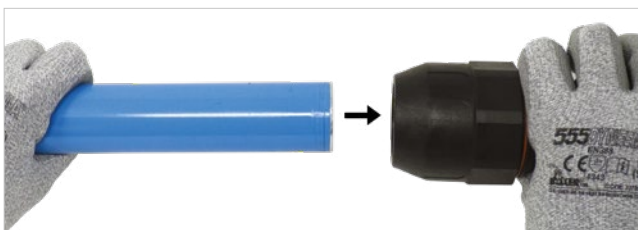

Manually remove the tube lengthwise, without tilting the tube inside the fitting.

In case of need, it is possible to re-connect the pipe to the fitting taking care to re-screw the nut in advance until the screwing witness completely disappears.



The F-Line.PRO system has been designed to make maintenance and expansion operations as easy as possible. It is possible to disconnect the pipe from the fitting simply by unscrewing the pipe in the event that it is then necessary to reconnect the same pipe in the same position.

In this case, unscrew the nut being careful not to move it from its longitudinal position with respect to the pipe. The same nut can be screwed back with the tube inserted to restore the original situation.





ASSEMBLY INSTRUCTION - QUICK BRANCH

Mod I82 - rev.1 01/2022

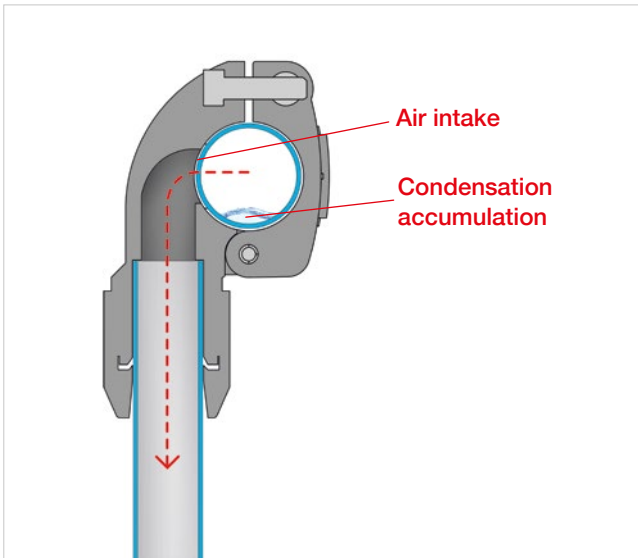

F-Line.PRO quick branches allow to get a quick branch from the main conduit without cutting the pipeline and without having the need to prepare the pipes in advance. Moreover, the air intake is positioned above the level at which the condensation accumulation could be inside the tube in order to grant an excellent air quality.



Position the quick branch at the opposite of its final installation position. Use the marker on the body in order to center it correctly on the tube.



Drill the tube with the proper tool FPTD.



Remove the quick branch and clean the hole so that no burrs will remain on the edges or on the tube surface.



Fix the branch so that the internal part will stay correctly in the hole. F-Line.PRO branches have a guided air intake that go inside the tube so that, once fixed, it will be impossible for them to move from their position. This system ensure the functioning, always granting the maximum air flow and eliminating the risk of leakage.



BRACKETING METHOD

Please, refer to the following indications in order to make a proper bracketing system for your F-Line.PRO network. We recommend the use of F-Line.PRO wall fasteners (FPST) and the related spacers (FPDST) in order to avoid any possible trouble and in order to keep the system safe.

DN	DISTANCE IN METERS BETWEEN WALL FASTENERS DEPENDING FROM THE MAXIMUM TEMPERATURE DIFFERENCE		
mm	< 20°C	30°C	40°C
20	2,5	2	1,5
25	3	2,5	2
40	4	3,5	3

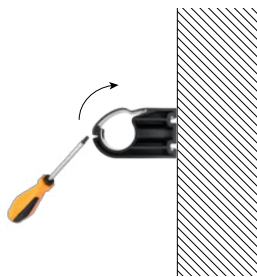

The F-Line.PRO wall fastener can be used both in horizontal or vertical position. Place the FPST at the desired height and open the hook with a screwdriver.



All wall fasteners can be installed using an M8 hexagonal nut to be inserted inside the FPST (by using a threaded bar). It's also possible to use self-tapping screws with a screw-anchor in case of installation on a wall or concrete.

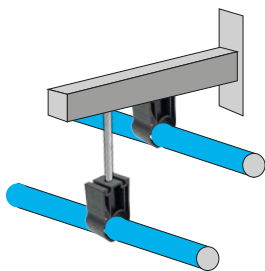

You can secure the wall fastener to any type of clamping system and then insert the tube into the wall fastener and set the hook.



Fasteners can be installed with spacers (FPDST) in order to compensate the distance from the wall.





-20°C ÷ +80°C



Working Pressure:

16 Bar

Negative Pressure:

- 0,95 Bar (- 95 kPa)



Air, non-aggressive gases and vacuum

Resistant to mechanical shocks and U.V.
Fire resistance. Non-flammable with no propagation of flame.

Tube: Aluminum AN AW 6060 T6

Light blue tube: RAL 5012

Green tube: RAL 6018

Grey tube: RAL 7001



Manufactured with seamless extrusion.

Exterior surface painted with polyester powder.

PED

SILICONE FREE



Products in compliance with EC Regulation 1907/2006



Products in compliance with the directive EU 2015/863

FPAL-4AZ

Aluminum pipe 4 meters light blue

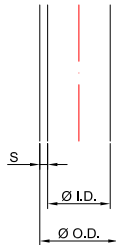

CODE	ØOD	ØID	S	WEIGHT (g/m)
FPAL2017-4AZ	20	17	1,5	200
FPAL2522-4AZ	25	22	1,5	275
FPAL4036-4AZ	40	36	2	585

FPAL-6AZ

Aluminum pipe 6 meters light blue

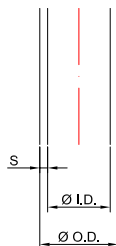

CODE	ØOD	ØID	S	WEIGHT (g/m)
FPAL2017-6AZ	20	17	1,5	200
FPAL2522-6AZ	25	22	1,5	275
FPAL4036-6AZ	40	36	2	585



FPAL-6GR

Aluminum pipe 6 meters grey

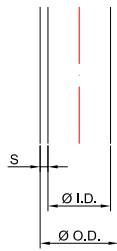

CODE	ØOD	ØID	S	WEIGHT (g/m)
FPAL2017-6GR	20	17	1,5	200
FPAL2522-6GR	25	22	1,5	275
FPAL4036-6GR	40	36	2	585

FPAL-6VD

Aluminum pipe 6 meters green

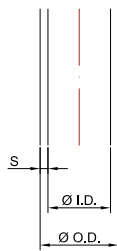

CODE	ØOD	ØID	S	WEIGHT (g/m)
FPAL2017-6VD	20	17	1,5	200
FPAL2522-6VD	25	22	1,5	275
FPAL4036-6VD	40	36	2	585

F-IS

Double bend

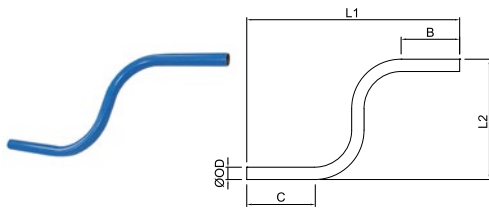

CODE	ØOD	B	C	L1	L2	g
F-IS2000-100	20	143,5	143,5	425	100	126
F-IS2000-195	20	95	110	345	195	109
F-IS2500	25	95	95	460	190	140



FPST

Fixing clip rigid pipe with insert for M8 nut

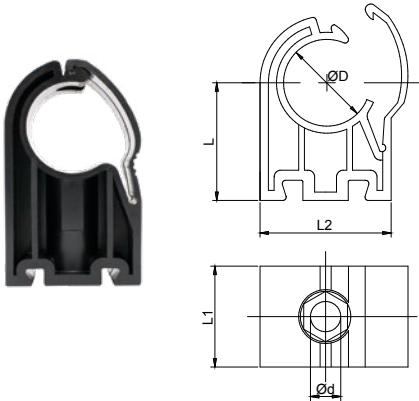

CODE	ØD	L	L1	L2	Ød	WEIGHT (g)
FPST20	20	35,0	30,0	31,0	9,0	18
FPST25	25	35,0	30,0	38,0	9,0	20
FPST40	40	70,0	40,0	60,0	9,0	74

M8 nut included

FPDST

Spacer for fixing clip rigid pipe

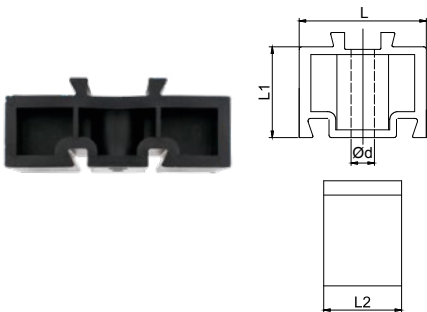

CODE	L	L1	L2	Ød	WEIGHT (g)
FPDST2032	49,0	35,0	30,0	9,0	24
FPDST4063	94,0	30,0	40,0	9,0	55

FPCL

Zinc-plated steel collar



CODE	TUBE Ø	THREAD	WIDTH	THICKNESS	SCREWS	STATIC LOAD (kN)	WEIGHT (g)
FPCL25	25	M8 - M10	20	1,5	M6x25	1	62,5
FPCL40	40	M8 - M10	20	1,5	M6x25	1	68,5

FPAN

Wall anchoring



CODE	THICKNESS	DRILL HOLE Ø X DEPTH	ANCHORING LENGHT	THREAD	WEIGHT (g)
FPAN60	10	10x50	60	M10x25	46
FPAN85	16	10x65	85	M10x40	56,6



FPMT

Beam clamp

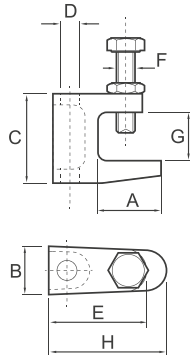

CODE	F	A	B	C	D	E	G	H	NOMINAL LOAD (N)	WEIGHT (g)
FPMTM8	M8	21	19	35	M8	35	18	38	1200	85

FPMP

Electrolytic zinc-plated wall bracket

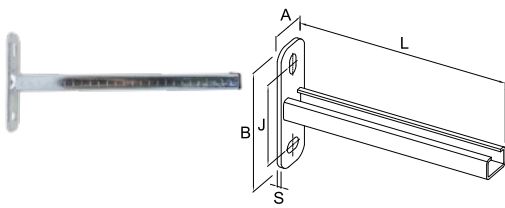

CODE	L	A	B	S	J	HOLE Ø	WEIGHT (g)
FPMP280	280	40	120	4	81,5	18x11	48

Bracket profile: 32/20x2,5 (Profile 23x11 width 35mm)
 Permissible load: 38kgf

FPMRS

Reinforced bracket

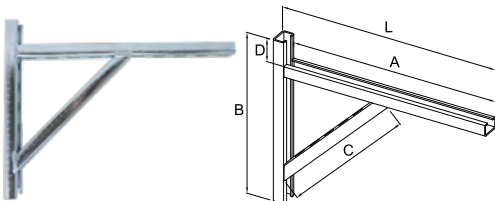

CODE	L	A	B	C	D	WEIGHT (g)
FPMRS370	370	345	275	250	40	1048
FPMRS545	545	520	380	380	46	1580

Bracket profile: 32/20x2,5 (Profile 23x11 width 35mm)
 Permissible load: 60kgf (FPMRS370)
 40kgf (FPMRS545)





-40°C ÷ +100°C
with hydraulic, synthetic and
petroleum-derived fluids

-40°C ÷ +70°C
with compressed air



Working Pressure:
16 Bar



Air, non-aggressive gases and
vacuum



Tube: Black synthetic rubber
reinforced with braided steel
Thread: Carbon steel

Resistant to synthetic fluids, petroleum-
based fluids, water-based fluids, lubricants,
hydrocarbons, fuels etc.

FPTUC

Tube for compressor connection with female swivel fittings

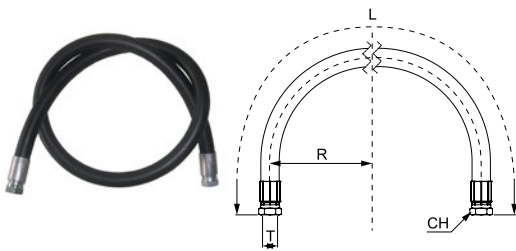

CODE	DN	ØID	ØOD	T	CH	R (BENDING RADIUS)	L (m)
FPTUC25G06	25	26,4	36,6	G 1"	38	300	0,5
FPTUC40G08	38	39,3	52,1	G 1-1/2"	55	500	1,32





-30°C ÷ +80°C



Working Pressure:

16 Bar

Negative Pressure:

- 0,95 Bar (- 95 kPa)



Air, non-aggressive gases and vacuum



Tube: Black SBR/NBR oil mist resistant. High tensile textile cords reinforcement. Black SBR abrasion and ozone resistant cover

Stem: Aluminum

Smooth textile surface.

Resistant to abrasion, weather conditions and aging.

FPTUX

Flexible expansion joint

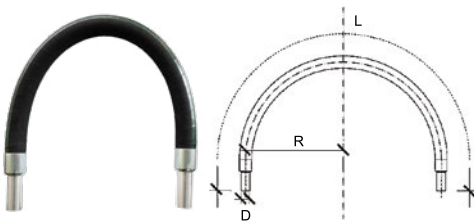

CODE	DN	ØID	ØOD	D	R (BENDING RADIUS)	L (m)
FPTUX25-1000	25	25,0	35,0	25	250	1
FPTUX25-2000	25	25,0	35,0	25	250	2
FPTUX40-1500	38	35,0	50,0	40	380	1,5
FPTUX40-3000	38	35,0	50,0	40	380	3



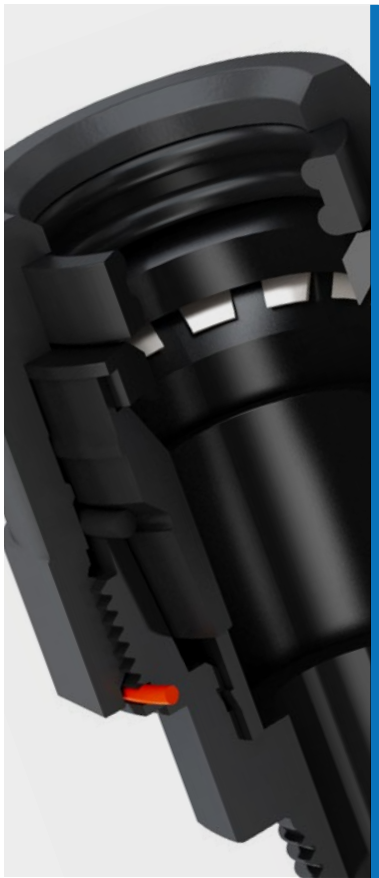

-20°C ÷ +80°C



Max. Working Pressure:

16 Bar

Negative Pressure:

- 0,95 Bar (- 95 kPa)



Compressed air,
non-aggressive gases and
vacuum



- Taper gas BSPT ISO 7
from R1/2" to R1-1/2"
- Parallel gas BSPP ISO 228
from G1/4" to G1"

Body: Reinforced PA
Aluminum (CA Version)

Tube Seal: NBR

Back Ring: HP technopolymer

Lock Claw: Stainless steel AISI 301

Lock Claw Support: HP technopolymer

Nut Seal: NBR

Nut: Reinforced PA

Screwing Indicator: Silicone

Tube Stop: HP technopolymer
(CA Version)

PED

SILICONE FREE



Products in compliance with
EC Regulation 1907/2006

RoHS3

Products in compliance with
the directive EU 2015/863

CONSTRUCTION DETAILS

Standard Version

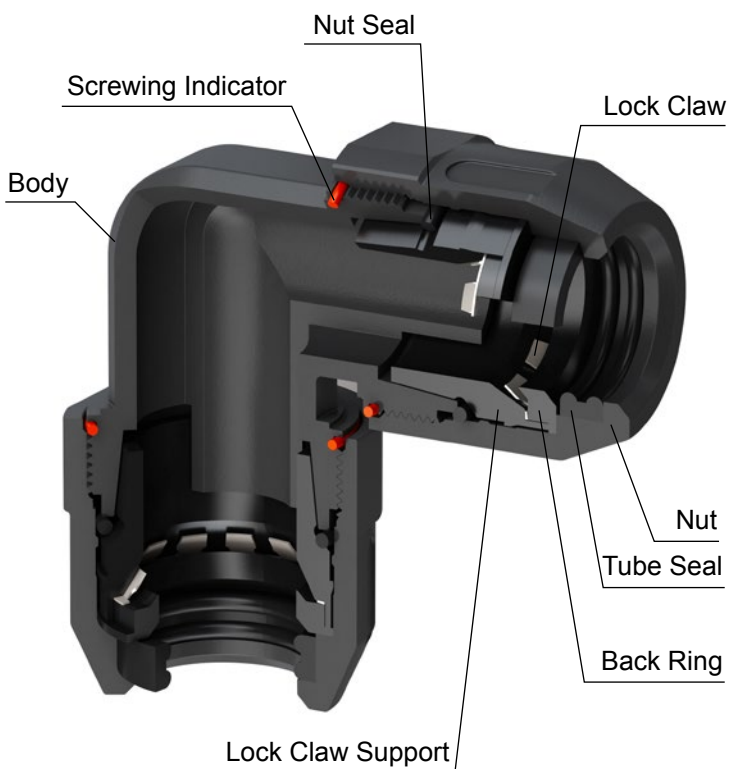

CA Version



FPC Male connector BSPT thread

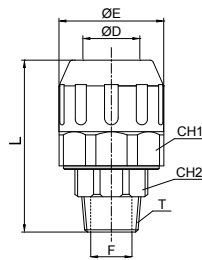

CODE	ØD	T	L	ØF	ØE	CH1	CH2	WEIGHT (g)
FPC20R04	20	R 1/2"	64	14	40,5	39	26	44,5
FPC25R04	25	R 1/2"	70,5	14	48	46	32	72
FPC25R05	25	R 3/4"	75,5	18	48	46	32	74
FPC40R06	40	R 1"	113,2	21	70	67	36	201

FPCA Male connector BSPT thread - aluminum body

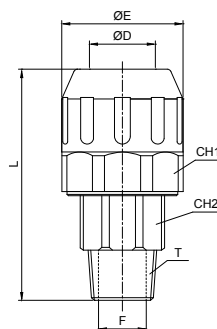

CODE	ØD	T	L	ØF	ØE	CH1	CH2	WEIGHT (g)
FPCA25R06	25	R 1"	88	21	48	46	36	141
FPCA40R08	40	R 1" 1/2"	116,1	36	70	67	50	312

FPUC Union connector

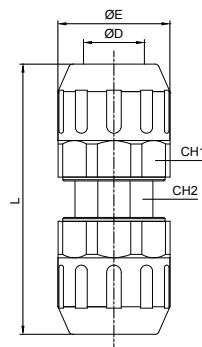

CODE	ØD	L	ØE	CH1	CH2	WEIGHT (g)
FPUC20	20	95	40,5	39	26	81,5
FPUC25	25	111	48	46	32	132
FPUC40	40	171,4	70	67	46	388

FPG Reduced union connector

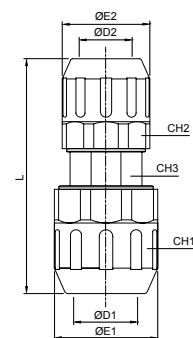

CODE	ØD1	ØD2	ØE1	ØE2	L	CH1	CH2	CH3	WEIGHT (g)
FPG2520	25	20	48	40,5	101,5	46	39	26	103,5
FPG4025	40	25	70	48	136,2	67	46	32	240



FPUL

Union elbow

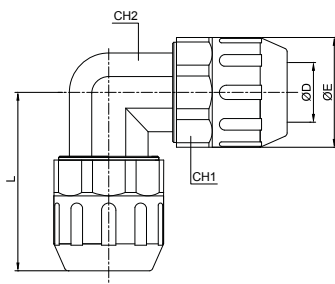

CODE	ØD	ØE	L	CH1	CH2	WEIGHT (g)
FPUL20	20	40,5	63,5	39	26	92,5
FPUL25	25	48	74,8	46	32	152
FPUL40	40	70	110,2	67	46	409

FPULH

Union elbow 135°

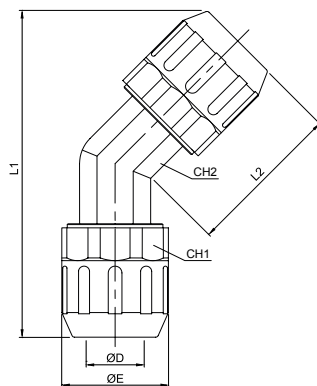

CODE	ØD	ØE	L1	L2	CH1	CH2	WEIGHT (g)
FPULH20	20	40,5	111	53,5	39	26	89
FPULH25	25	48	131	63	46	32	140,5
FPULH40	40	70	201	98,2	67	46	387

FPUT

Union tee

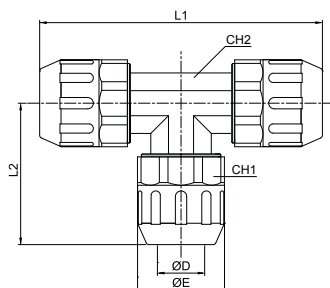

CODE	ØD	L1	L2	ØE	CH1	CH2	WEIGHT (g)
FPUT20	20	127	63,5	40,5	39	26	135
FPUT25	25	149,6	74,8	48	46	32	221
FPUT40	40	220,4	110,2	70	67	46	619

FPGT

Reduced union tee

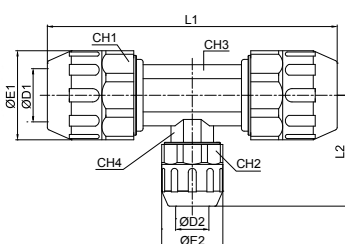

CODE	ØD1	ØD2	L1	L2	ØE1	ØE2	CH1	CH2	CH3	CH4	WEIGHT (g)
FPGT4025	40	25	220,4	83,4	70	48	67	46	46	32	479



FPGT-G

Female tee BSP thread

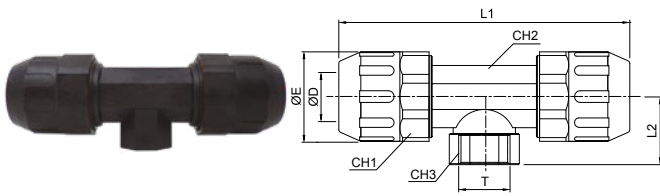

CODE	ØD	T	ØE	L1	L2	CH1	CH2	CH3	WEIGHT (g)
FPGT25G05	25	G 3/4"	48	149,6	43	46	32	36	161,5
FPGT40G06	40	G 1"	70	220,4	44	67	46	46	420

FPPF

End plug

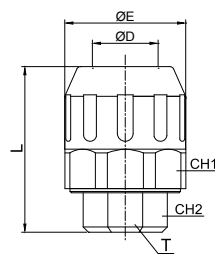

CODE	ØD	* T	L	ØE	CH1	CH2	WEIGHT (g)
FPPF20	20	G 1/4"	56,5	40,5	39	24	46
FPPF25	25	G 1/4"	63	48	46	24	72
FPPF40	40	G 1/4"	88,2	70	67	24	187

* Blind thread

FPBR

Quick branch

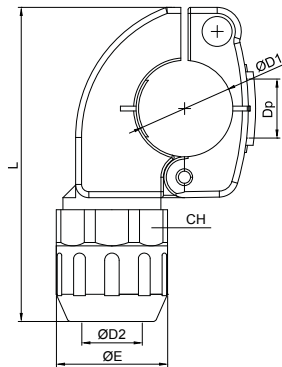

CODE	ØD1	ØD2	L	Dp	ØE	CH	WEIGHT (g)
FPBR2520	25	20	112	18,6	40,5	39	241
FPBR4020	40	20	122	24,5	40,5	39	278
FPBR4025	40	25	130,4	24,5	48	46	290

FPBR-G

Quick branch female BSP thread

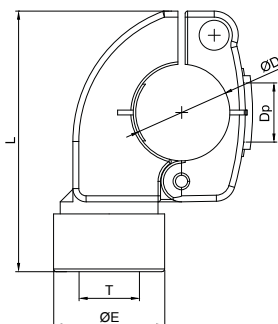

CODE	ØD	T	L	Dp	ØE	WEIGHT (g)
FPBR25G04	25	G 1/2"	90	18,6	34	232,5
FPBR40G05	40	G 3/4"	100	24,5	40,5	287



FPSAS

Single applique - Stainless steel AISI 316L

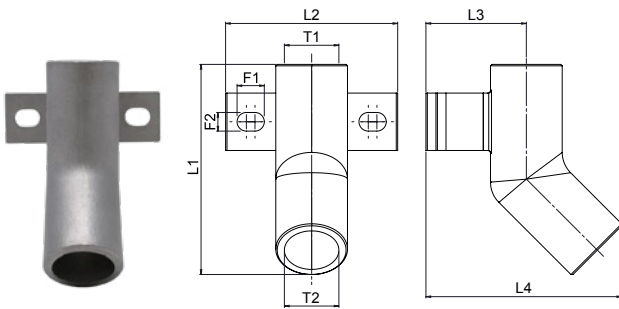

CODE	T1	T2	L1	L2	L3	L4	F1	F2	WEIGHT (g)
FPSAS-G04G04	G 1/2"	G 1/2"	73,5	60	35	68,5	9,5	6,5	159

FPDAS

Double applique - Stainless steel AISI 316L

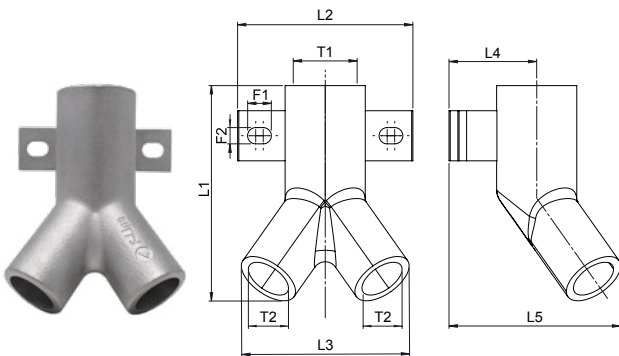

CODE	T1	T2	L1	L2	L3	L4	L5	F1	F2	WEIGHT (g)
FPDAS-G05G04	G 3/4"	G 1/2"	86	70	67	35	68,5	9,5	6,5	265

FPWLM1

Single applique - Aluminum

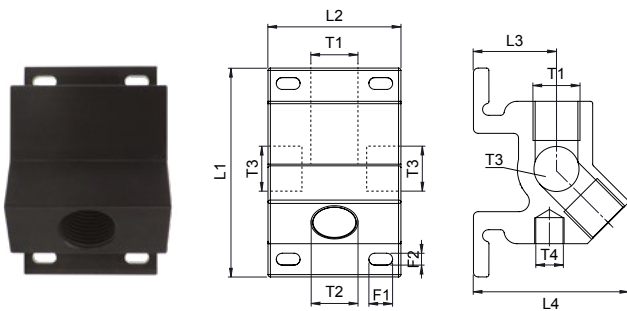

CODE	T1	T2	T3	*T4	L1	L2	L3	L4	F1	F2	WEIGHT (g)
FPWLM1-G04G04	G 1/2"	1xG 1/2"	G 1/2"	G 1/4"	88	56	35	66	10	5	325

* Blind thread

FPWLM2

Double applique - Aluminum

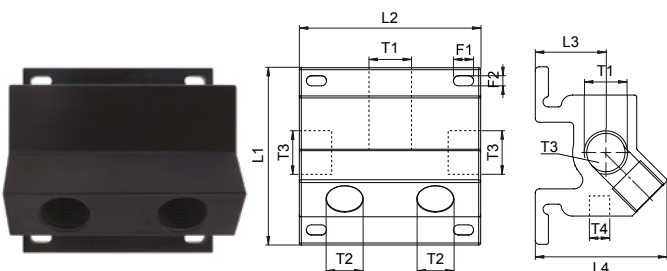

CODE	T1 IN	T2 OUT	T3	*T4	L1	L2	L3	L4	F1	F2	WEIGHT (g)
FPWLM2-G04G04	G 1/2"	2xG 1/2"	G 1/2"	G 1/4"	88	90	35	65,7	10	5	530
FPWLM2-G05G04	G 3/4"	2xG 1/2"	G 1/2"	G 1/4"	88	90	35	65,7	10	5	515

* Blind thread



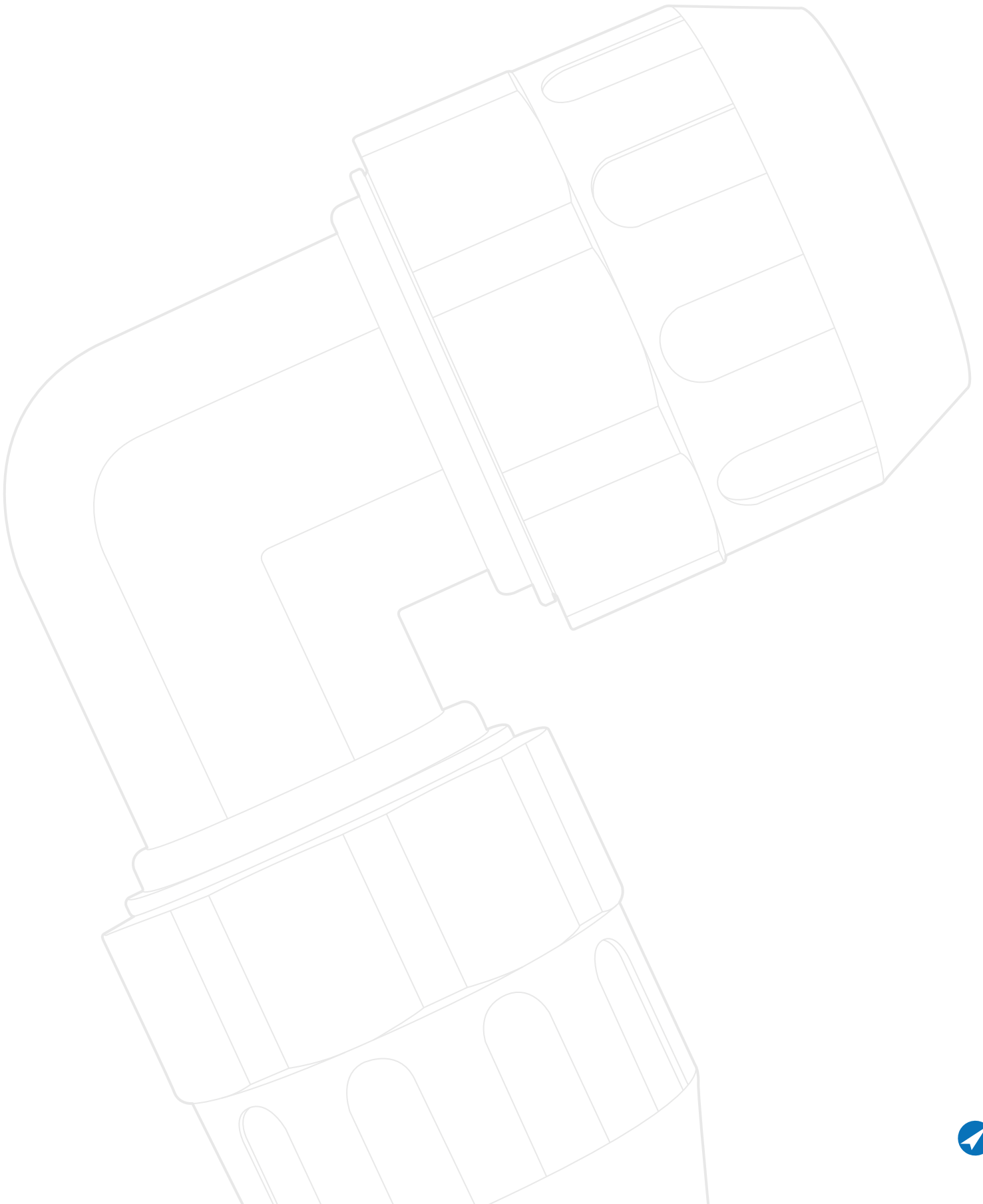



9210 - 9220 - 9250
 -20°C ÷ +150°C
 9210PRO - 9220PRO
 -20°C ÷ +80°C



1610
 -5°C ÷ +70°C
 9120F
 0°C ÷ +60°C
 9611
 -10°C ÷ +110°C



PN (Nominal Pressure)
 See the table



Compressed air and
 non-aggressive gases



- Taper gas BSPT ISO 7
 from R1/4" to R3/4"
 - Parallel gas BSPP ISO 228-1
 from G1/4" to G1-1/2"

9210 - 9220 - 9250

Body: Nickel plated brass
 Body end: Nickel plated brass
 Seat: PTFE
 Ball: Chrome plated brass
 Stem: Nickel plated brass
 O'Ring: NBR
 Seal: PTFE
 Packing nut: Nickel plated brass
 Handle: Steel
 Nut: Steel



1610

Body: Chrome plated brass
 Slide: Blue anodized aluminum
 O'Ring: NBR 70
 Elastic ring: Steel

1110 & 1112

Body: Nickel plated brass



Products in compliance with
 EC Regulation 1907/2006



Products in compliance with
 the directive EU 2015/863

9210PRO

Full bore ball valve with fittings

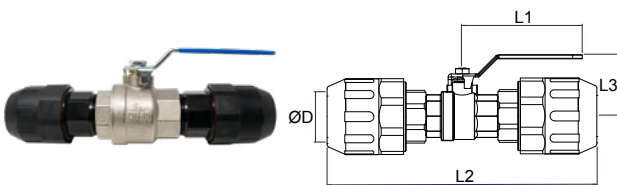

CODE	ØD	DN	PN	L1	L2	L3	WEIGHT (g)
9210PRO25	25	21	16	92	216	59	704
9210PRO40	40	36	16	150	290	75	1583

For fittings construction details & technical datasheet, please refer to page 24.

9220PRO

Full bore ball valve with fitting and male BSPP thread

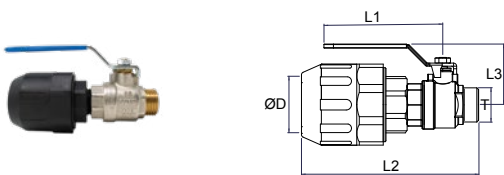

CODE	ØD	T	DN	PN	L1	L2	L3	WEIGHT (g)
9220PRO20G04	20	G 1/2"	14	16	92	102,5	43	217
9220PRO25G04	25	G 1/2"	14	16	92	108,5	43	246
9220PRO25G05	25	G 3/4"	18	16	92	121	47	319
9220PRO25G06	25	G 1"	21	16	115	143	59	554
9220PRO40G08	40	G 1-1/2"	36	16	150	191	75	1242

For fittings construction details & technical datasheet, please refer to page 24.



9120-F

Brass miniball valve M/F, BSPP Thread

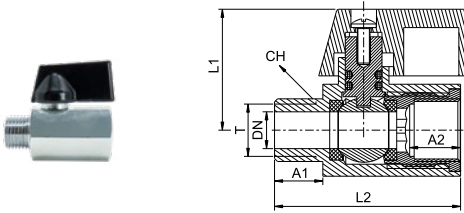

CODE	T	PN	DN	A1	A2	L1	L2	CH	WEIGHT (g)
9120TR14-F	G 1/4"	16	8	10	10	26	40,5	20	74

9611

Brass drain valve, BSPT thread

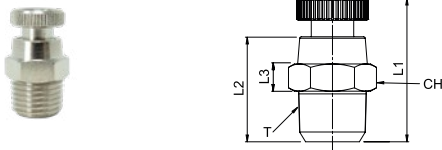

CODE	T	PN	L1	L2	L3	CH	WEIGHT (g)
9611TR14	R 1/4"	16	24	16	5	14	20

9210

Full bore ball valve, threaded ends BSPP F/F

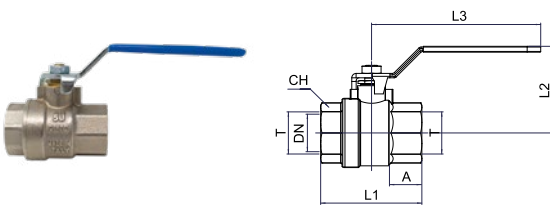

CODE	T	DN	PN	A	L1	L2	L3	CH	WEIGHT (g)
9210TR12	G 1/2"	15	50	11	50	43	92	25	158
9210TR34	G 3/4"	20	50	13	57	47	92	31	255
9210TR1	G 1"	25	40	15	70	59	115	38	422
9210TR112	G 1-1/2"	40	32	18	90	75	150	54	959

9220

Full bore ball valve, threaded ends BSPP M/F

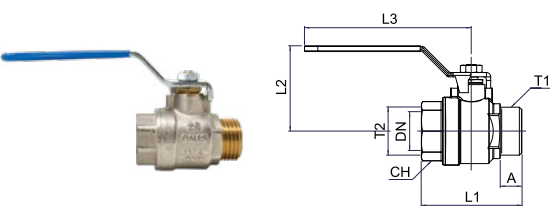

CODE	T1	T2	DN	PN	L1	L2	L3	CH	WEIGHT (g)
9220TR12	G 1/2"	G 1/2"	15	50	92	50	43	25	174
9220TR34	G 3/4"	G 3/4"	20	50	92	58	47	31	245
9220TR1	G 1"	G 1"	25	40	115	70	59	38	413
9220TR112	G 1-1/2"	G 1-1/2"	40	32	150	91	75	54	930

9250

Full bore ball valve, threaded ends BSPP M/F - butterfly lever

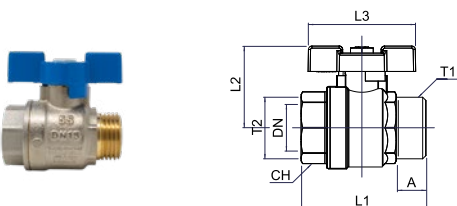

CODE	T1	T2	DN	PN	L1	L2	L3	CH	WEIGHT (g)
9250TR12	G 1/2"	G 1/2"	15	50	50	50	37	25	153
9250TR34	G 3/4"	G 3/4"	20	50	50	58	40	31	224
9250TR1	G 1"	G 1"	25	40	61	70	47	38	364



1610

Slide valve BSPP thread

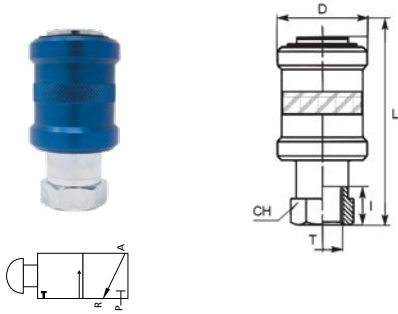

CODE	T	PN	D	L	I	CH	FLOW (Nl/min)	WEIGHT (g)
1610TR12	G 1/2"	10	40	75	15	27	3800	212
1610TR34	G 3/4"	10	50	83	16,5	32	5700	317

1110

Nipple BSPT thread

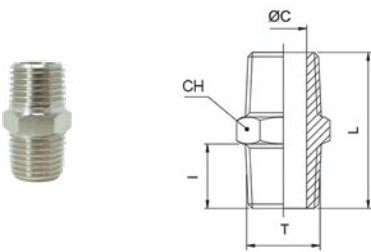

CODE	T	ØC	L	I	H	WEIGHT (g)
1110TR12	R 1/2"	15	30,5	12,5	22	79
1110TR34	R 3/4"	20	34,5	14	27	61

1112

Reduced nipple BSPT thread

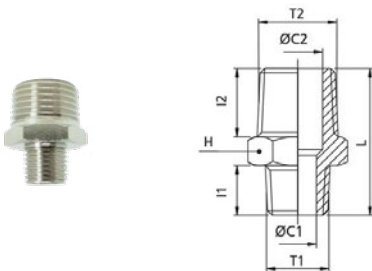

CODE	T1	T2	ØC1	ØC2	L	I1	I2	H	WEIGHT (g)
1112TR1234	R 1/2"	R 3/4"	15	20	32,5	12,5	14	27	58



FPTD

Drilling tool



CODE	Ø TUBE	Ø HOLE	WEIGHT (g)
FPTD25	25	18	65
FPTD40	40	24	77

FPCH

Wrench for tightening nut fittings

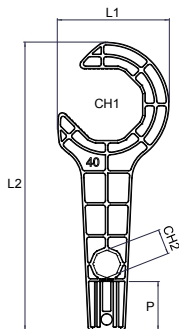

CODE	DN	CH1	L1	L2	* P	CH2	WEIGHT (g)
FPCH20	20	39	66	170	24,5	-	104
FPCH25	25	46	75	200	29	-	153
FPCH40	40	67	105	270	45,5	24	269

* Tube insertion depth marking function included

CH2: Hexagon for use with FPPF end plug only available on FPCH40 (Ø40)

FPTT

Metal pipe cutter



CODE	Ø MIN.	Ø MAX.	WEIGHT (g)
FPTT1632	16	32	350
FPTT1663	16	63	800

FPUS

Beveling cone



CODE	Ø MIN.	Ø MAX.	WEIGHT (g)
FPUS1650	16	50	428



FPHBT

Hand beveling



CODE	WEIGHT (g)
FPHBT	30,5

R-PTFE-PROF

Teflon tape for professional use



CODE	THICKNESS	WIDTH	CONTAINER
R-PTFE190215-PROF	0,2 mm	3/4"	15 m

TEMPERATURE

-200°C ÷ +260°C

FEATURES

The PTFE thread sealing tape of unsintered PTFE is mainly used as a thread sealing element. It resists all known chemical compound and solvents, with the exception of gaseous Fluorine at high temperature, Trifluoro Chlorine, alkali metals either molten or in solution. It can be used in a temperature range: -200°C to +260°C; has a low coefficient of friction, is tasteless, insoluble, and doesn't smell. The tapes are normally available on plastic reels. Is compounded from virgin material and is produced through a process called "Paste Extrusion".

LOX1810

Low strength PTFE anaerobic adhesive for sealing of metal thread pipe joints



CODE	HANDLING TIME	FUNCTIONAL CURE TIME	FULL CURE TIME	MAX THREAD Ø / GAP FILLING	CONTAINER
LOX1810	20 - 40 min	1 - 3 hours	5 - 10 hours	2" / 0,30 mm	75 ml

TEMPERATURE

-55°C ÷ +150°C

FEATURES

Anaerobic adhesive for sealing of metal thread pipe joints. Suitable for gas, LP gas, compressed air, gasoline and oil, industrial fluids, CFC, water and several chemicals. Low friction coefficient will assure easy assembly. Thixotropic property prevents migration from thread of the sealant before or during curing. It replaces P.T.F.E. tape and yarn. Cured product provides elastic film. Shocks and vibrations resistant; unaffected sealing properties in the temperature range from -55 to +150°C. Easy dismantling is assured even after years.

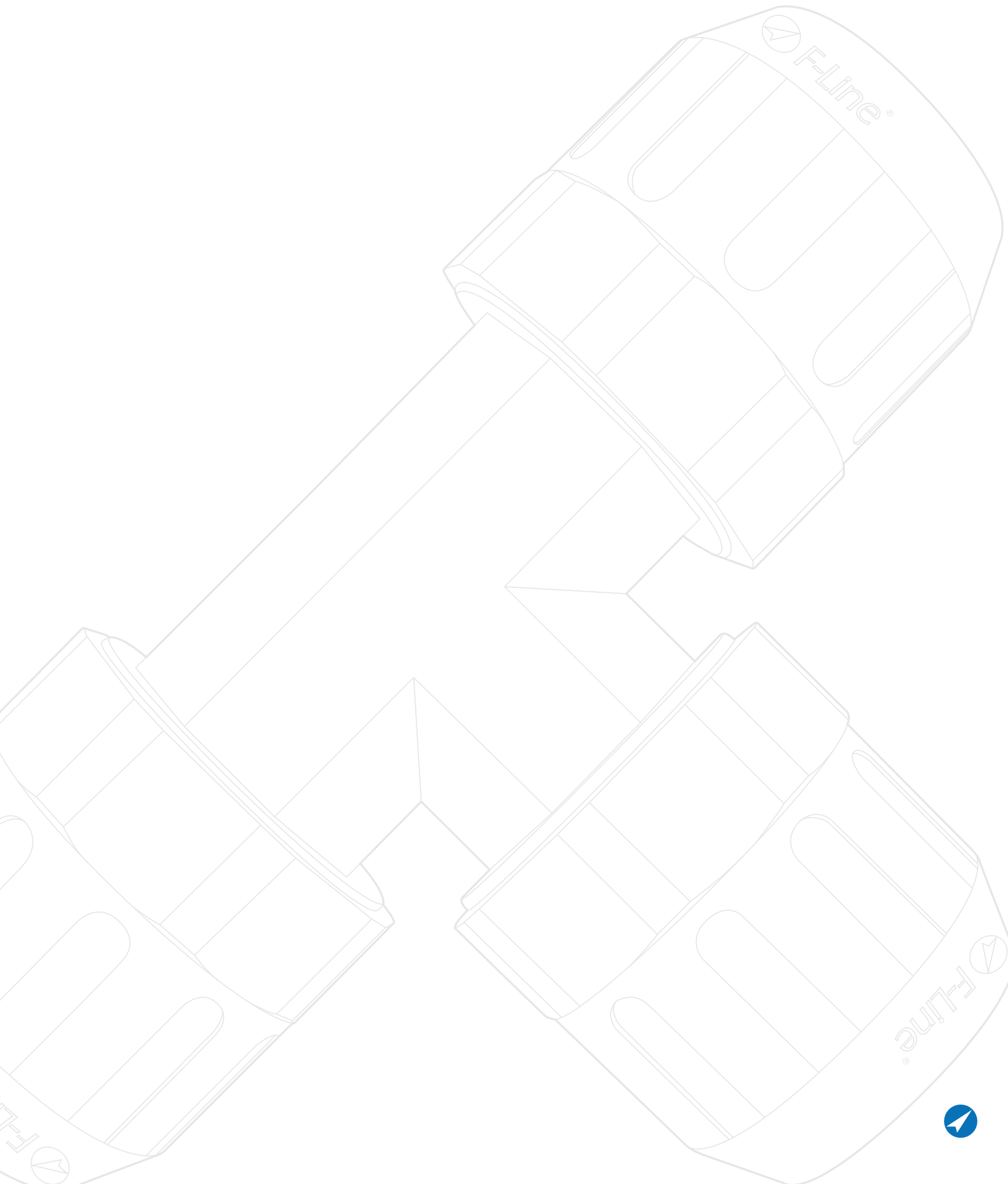



-15°C ÷ +80°C



Working Pressure:
16 Bar



Compressed air



- Taper gas BSPT ISO 7
from R1/4" to R1/2"
- Parallel gas BSPP ISO 228
from G1/4" to G1/2"



Body: Nickel plated brass with
6 stainless steel spheres

PROFILE - TIERRE UNIVERSAL SERIES

The strip 8400 Series allows you to use 4 different profiles by managing a single quick coupling. A practical solution to manage profiles that are not compatible with each other.

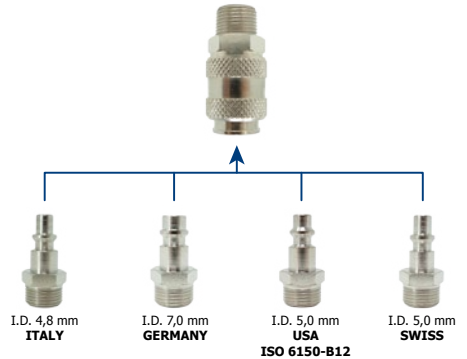

Products in compliance with
EC Regulation 1907/2006



Products in compliance with
the directive EU 2015/863

AIR FLOW

TIERRE UNIVERSAL SERIES

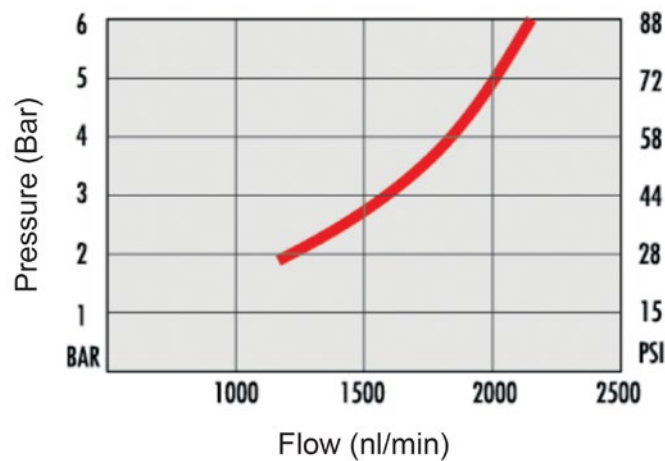

8410FM

Male quick coupler BSPT thread

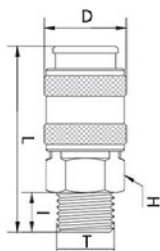

CODE	T	I	D	L	H
8410FM02	R 1/4"	11,0	24,0	58,0	20
8410FM03	R 3/8"	11,5	24,0	54,0	20
8410FM04	R 1/2"	14,0	24,0	56,5	22

8420FF

Female quick coupler BSPP thread

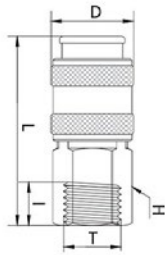

CODE	T	I	D	L	H
8420FF02	G 1/4"	11,0	24,0	55,0	20
8420FF03	G 3/8"	12,0	24,0	55,0	20
8420FF04	G 1/2"	14,0	28,0	55,0	25

8430RE

Barb connector quick coupler

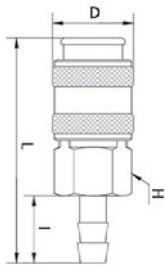

CODE	Ø INT. TUBO	I	BARB	D	L	H
8430RE06	6	20,0	6,5	24,0	67,0	20
8430RE08	8	20,0	9	24,0	67,0	20
8430RE10	10	20,0	11,5	24,0	67,0	20
8430RE12	12	24,0	13,5	24,0	71,0	20

8440PO

Hose connector quick coupler

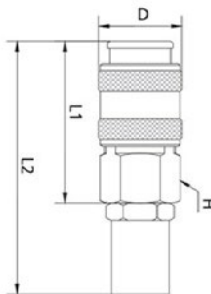

CODE	Ø	D	L1	L2	H
8440PO610	6x10	24	47,0	73,0	20
8440PO612	6x12	24	47,0	73,0	20
8440PO614	6x14	24	47,0	73,5	20
8440PO812	8x12	24	47,0	73,0	20
8440PO814	8x14	24	47,0	73,5	20
8440PO817	8x17	24	47,0	73,5	20
8440PO10145	10x14,5	24	47,0	73,5	20
8440PO1017	10x17	24	47,0	73,5	20
8440PO1019	10x19	24	47,0	77,0	20

8450MO

Spring quick coupler

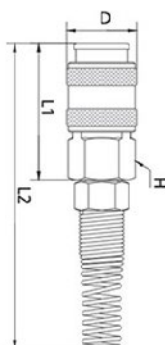

CODE	Ø	D	L1	L2	H
8450MO58	5x8	24,0	47,0	148,0	20
8450MO68	6x8	24,0	47,0	148,0	20
8450MO6510	6,5x10	24,0	47,0	148,0	20
8450MO810	8x10	24,0	47,0	148,0	20
8450MO812	8x12	24,0	38,0	155,0	20
8450MO1012	10x12	24,0	38,0	155,0	20



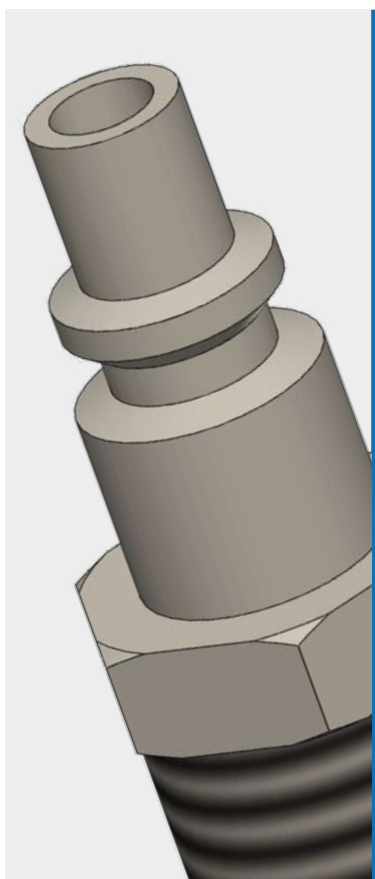

-18°C ÷ +80°C

Working pressure:
12 Bar

4,8 mm

FLOW

1600 l/mm



Compressed air

Parallel gas BSPP ISO 228
from G 1/8" to G 1/2"

Body: Nickel plated brass

PROFILE - ITALY SERIESProducts in compliance with
EC Regulation 1907/2006Products in compliance with
the directive EU 2015/863**8260MM**

Male connection BSPP thread



CODE	THREAD	LENGTH	WRENCH
8260MM01	G 1/8"	34,7	13
8260MM02	G 1/4"	37,9	14
8260MM03	G 3/8"	38,2	17
8260MM04	G 1/2"	42,1	22

8270FM

Female connection BSPP thread



CODE	THREAD	LENGTH	WRENCH
8270FM01	G 1/8"	29	13
8270FM02	G 1/4"	37	15
8270FM03	G 3/8"	38,1	19
8270FM04	G 1/2"	42	25



8230PO

Connection with hose connector



CODE	ØD	LENGTH	WRENCH 1	WRENCH 2
8230PO610	6x10	55,5	13	15
8230PO612	6x12	55,5	13	15
8230PO613	6x13	54,8	13	16
8230PO614	6x14	55,7	12	17
8230PO716	7x16	55,1	13	19
8230PO812	8x12	55	13	15
8230PO813	8x13	55	13	16
8230PO815	8x15	55	13	18
8230PO817	8x17	55,4	13	20
8230PO1017	10x17	57,9	13	20
8230PO1019	10x19	59,8	13	22

8285BM

Bayonet male connection



CODE	ØD	LENGTH
8285BM55	5,5	155,8

8295MO

Connection with spring

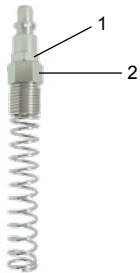

CODE	ØD	LENGTH	WRENCH 1	WRENCH 2
8295MO46	4x6	112,1	12	12
8295MO58	5x8	125,5	13	13
8295MO68	6x8	124,9	13	13
8295MO6510	6,5x10	126	12	15
8295MO810	8x10	123,7	13	15
8295MO812	8x12	125,5	15	17
8295MO1012	10x12	127,5	15	17



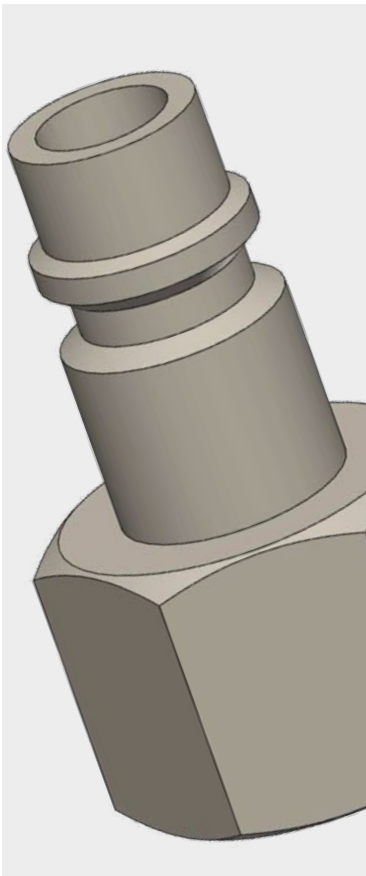

-18°C ÷ +80°C

Working pressure:
12 Bar

7,0 mm

FLOW

2000 l/mm



Compressed air

Parallel gas BSPP ISO 228
from G 1/8" to G 1/2"

Body: Nickel plated brass

PROFILE - GERMANY SERIESProducts in compliance with
EC Regulation 1907/2006Products in compliance with
the directive EU 2015/863**8360MM****Male connection BSPP thread**

CODE	THREAD	LENGTH	WRENCH
8360MM01	G 1/8"	32	12
8360MM02	G 1/4"	33,5	14
8360MM03	G 3/8"	35,5	17
8360MM04	G 1/2"	38,4	22

8370FM**Female connection BSPP thread**

CODE	THREAD	LENGTH	WRENCH
8370FM02	G 1/4"	33,1	15
8370FM03	G 3/8"	35	19
8370FM04	G 1/2"	38	25



8340PO

Connection with hose connector



CODE	ØD	LENGTH	WRENCH 1	WRENCH 2
8340PO610	6x10	54	13	15
8340PO612	6x12	54	13	15
8340PO614	6x14	53	13	17
8340PO716	7x16	53	13	18
8340PO812	8x12	54	13	15
8340PO815	8x15	54	13	18
8340PO817	8x17	54	13	20
8340PO1019	10x19	58	13	22

8380RE

Connection with barb connector



CODE	Ø INT. TUBE	LENGTH
8380RE06	6	39,4
8380RE07	7	59
8380RE08	8	63,4
8380RE09	9	41,3
8380RE10	10	63,5
8380RE11	11	63,5
8380RE12	12	63,6
8380RE13	13	66,3
8380RE14	14	66,7

8395MO

Connection with spring



CODE	ØD	LENGTH	WRENCH 1	WRENCH 2
8395MO46	4x6	110	13	12
8395MO58	5x8	119,5	13	13
8395MO68	6x8	120	13	13
8395MO6510	6,5x10	121	13	15
8395MO810	8x10	121	13	15
8395MO812	8x12	123	15	17
8395MO1012	10x12	121	15	17



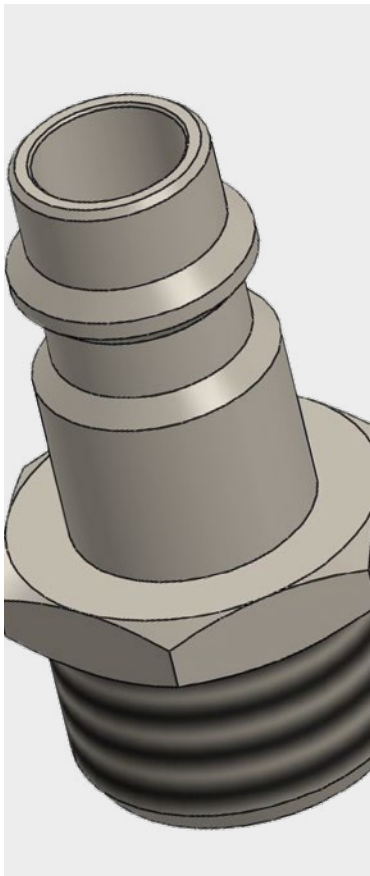

-18°C ÷ +80°C



Working pressure:
12 Bar



5,0 mm

FLOW

1600 l/mm



Compressed air



Parallel gas BSPP ISO 228
from G 1/4" to G 1/2"



Body: Nickel plated brass

PROFILE - USA / ISO 6150-B12 SERIES



Products in compliance with
EC Regulation 1907/2006



Products in compliance with
the directive EU 2015/863

8060MM

Male connection BSPP thread



CODE	THREAD
8060MM02	G 1/4"
8060MM03	G 3/8"
8060MM04	G 1/2"

8070FM

Female connection BSPP thread



CODE	THREAD
8070FM02	G 1/4"
8070FM03	G 3/8"
8070FM04	G 1/2"



8080RE

Connection with barb connector



CODE	Ø INT. TUBE
8080RE06	6
8080RE08	8
8080RE10	10
8080RE12	12

8085PO

Connection with hose connector



CODE	Ø
8085PO610	6x10
8085PO612	6x12
8085PO614	6x14
8085PO812	8x12
8085PO814	8x14
8085PO817	8x17
8085PO10145	10x14,5
8085PO1017	10x17
8085PO1019	10x19

8090MO

Connection with spring



CODE	Ø
8090MO46	4x6
8090MO58	5x8
8090MO68	6x8
8090MO810	8x10
8090MO6510	6,5x10
8090MO812	8x12
8090MO1012	10x12



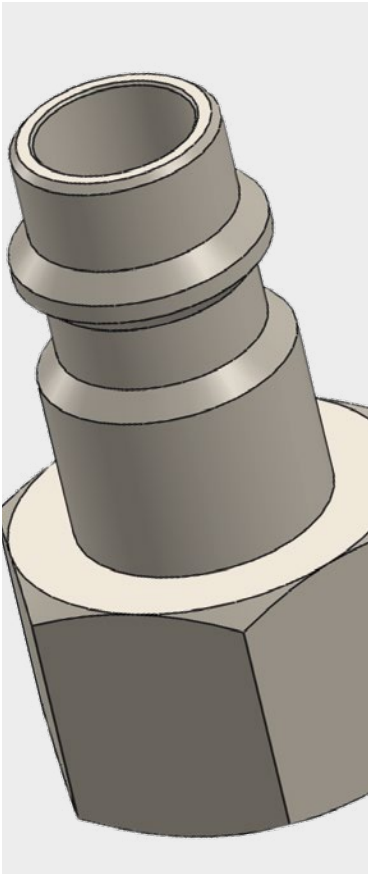

-15°C ÷ +80°C

Working pressure:
16 Bar

5,0 mm

FLOW

2000 l/mm



Compressed air

Parallel gas BSPP ISO 228
from G 1/4" to G 1/2"

Body: Nickel plated brass

PROFILE - SWISS SERIESProducts in compliance with
EC Regulation 1907/2006Products in compliance with
the directive EU 2015/863**8460MM****Male connection BSPP thread**

CODE	THREAD
8460MM02	G 1/4"
8460MM03	G 3/8"
8460MM04	G 1/2"

8470FM**Female connection BSPP thread**

CODE	THREAD
8470FM02	G 1/4"
8470FM03	G 3/8"
8470FM04	G 1/2"



8480RE

Connection with barb connector



CODE	Ø INT. TUBE
8480RE06	6
8480RE08	8
8480RE10	10
8480RE12	12

8485PO

Connection with hose connector



CODE	Ø
8485PO610	6x10
8485PO612	6x12
8485PO614	6x14
8485PO812	8x12
8485PO814	8x14
8485PO817	8x17
8485PO10145	10x14,5
8485PO1017	10x17
8485PO1019	10x19

8490MO

Connection with spring



CODE	Ø
8490MO46	4x6
8490MO58	5x8
8490MO68	6x8
8490MO6510	6,5x10
8490MO810	8x10
8490MO812	8x12
8490MO1012	10x12



ISO 6150 B12

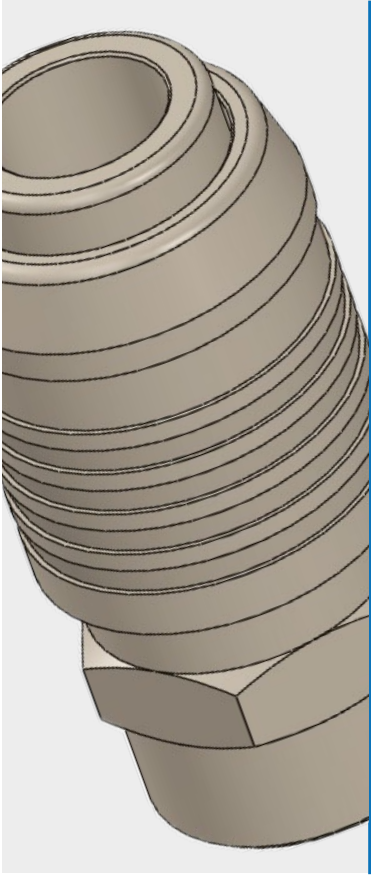

 -10°C ÷ +95°C

Working pressure
FLUID-10N:
 0-12 Bar (suggest)
 35 Bar (max.)
FLUID-10S:
 0-7 Bar (suggest)

 Compressed air

DN 5,5 mm

 - Taper gas BSPT ISO 7 from R 1/4" to R 1/2"
 - Parallel gas BSPP ISO 228 from G 1/4" to G 1/2"

FLOW

750 l/min (FLUID-10N)
 840 l/min (FLUID-10S - SAFETY)

CONFIGURATIONS

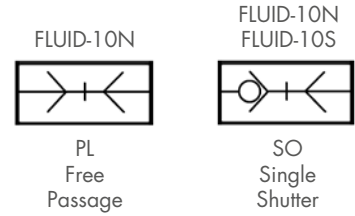

  Products in compliance with EC Regulation 1907/2006

 **RoHS3** Products in compliance with the directive EU 2015/863

COMPONENTS	FLUID-10N	FLUID-10S - SAFETY
Body	Nickel plated steel	Nickel plated steel
Adapter	Nickel plated brass	Nickel plated brass
Slide	Nickel plated steel	Nickel plated steel
Valve	Nickel plated brass	Nickel plated brass
Spring	Stainless steel AISI 302	Stainless steel AISI 302
Ball	Chrome steel	Chrome steel
Retaining ring	Stainless steel AISI 302	Stainless steel AISI 302
External cartridges	-	Nickel plated steel
Seal	NBR	NBR

CONNECTION	NE-10
Body	Nickel plated steel

FLOW DROP FLUID-10N

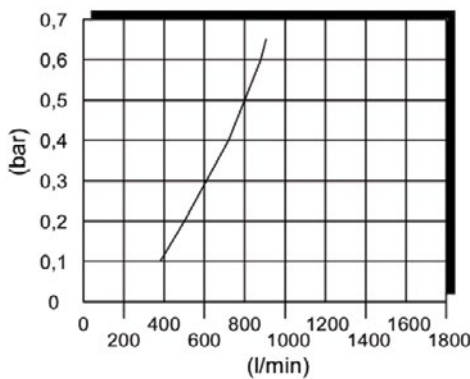

FLOW DROP FLUID-10S

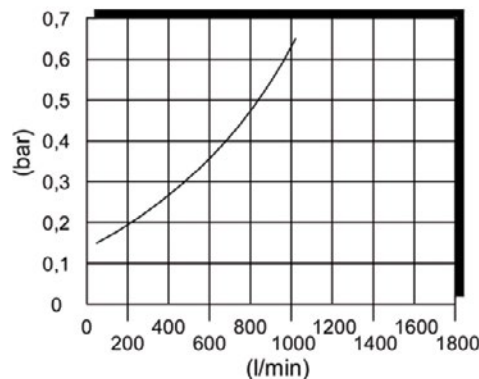

All charts have been created considering a pressure of 6 Bar with low drop of 0.5 Bar and simple lock

FLUID-10N-M

Male quick coupler BSPT thread

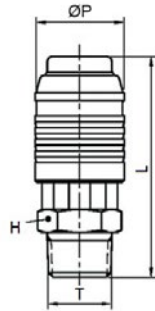

CODE	T	ØP	L	H
FLUID-10N-M1/4	R 1/4"	23,4	54,5	19
FLUID-10N-M1/4-PL	R 1/4"	23,4	54,5	19
FLUID-10N-M3/8	R 3/8"	23,4	55,5	19
FLUID-10N-M3/8-PL	R 3/8"	23,4	55,5	19
FLUID-10N-M1/2	R 1/2"	23,4	60	22
FLUID-10N-M1/2-PL	R 1/2"	23,4	60	22

MALE QUICK COUPLER BSPP THREAD

FLUID-10N-M1/4G	G 1/4"	23,4	53	21
FLUID-10N-M1/4G-PL	G 1/4"	23,4	53	21
FLUID-10N-M3/8G	G 3/8"	23,4	54,5	21
FLUID-10N-M3/8G-PL	G 3/8"	23,4	54,5	21
FLUID-10N-M1/2G	G 1/2"	23,4	57,5	24
FLUID-10N-M1/2G-PL	G 1/2"	23,4	57,5	24

-PL: Free passage

FLUID-10N-H

Female quick coupler BSPP thread

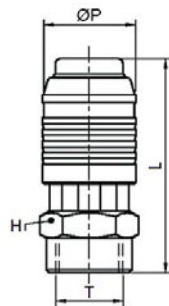

CODE	T	ØP	L	H
FLUID-10N-H1/4	G 1/4"	23,4	52,5	19
FLUID-10N-H1/4-PL	G 1/4"	23,4	52,5	19
FLUID-10N-H3/8	G 3/8"	23,4	54	22
FLUID-10N-H3/8-PL	G 3/8"	23,4	54	22
FLUID-10N-H1/2	G 1/2"	23,4	58,2	25
FLUID-10N-H1/2-PL	G 1/2"	23,4	58,2	25

-PL: Free passage

FLUID-10N-E

Quick coupler with barb connector

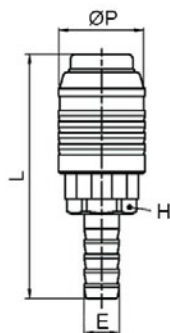

CODE	E	ØP	L	H
FLUID-10N-E6	7,2	23,4	62	19
FLUID-10N-E6-PL	7,2	23,4	62	19
FLUID-10N-E8	9,2	23,4	62	19
FLUID-10N-E8-PL	9,2	23,4	62	19
FLUID-10N-E10	11,2	23,4	66	19
FLUID-10N-E10-PL	11,2	23,4	66	19
FLUID-10N-E12	13,2	23,4	71	19
FLUID-10N-E12-PL	13,2	23,4	71	19

-PL: Free passage



FLUID-10N-PM

Joint push-on fittings

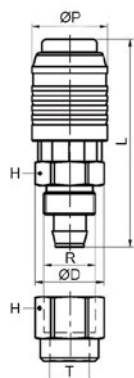

CODE	Ø TUBE	R	ØP	L	H	H1
FLUID-10N-PM08	8x12	M16x1	23,4	64,7	19	19
FLUID-10N-PM08-PL	8x12	M16x1	23,4	64,7	19	19
FLUID-10N-PM10	10x15	M20x1	23,4	69,5	22	22
FLUID-10N-PM10-PL	10x15	M20x1	23,4	69,5	22	22

To used with PU-PVC tube

-PL: Free passage

FLUID-10S-M

Safety male quick coupler BSPT thread

SAFETY

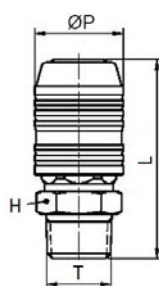

CODE	T	ØP	L	H
FLUID-10S-M1/4	R 1/4"	26,6	55,7	19
FLUID-10S-M3/8	R 3/8"	26,6	56,7	19
FLUID-10S-M1/2	R 1/2"	26,6	61,2	22
SAFETY MALE QUICK COUPLER BSPP THREAD				
FLUID-10S-M1/4G	G 1/4"	26,6	54,2	21
FLUID-10S-M3/8G	G 3/8"	26,6	55,7	21
FLUID-10S-M1/2G	G 1/2"	26,6	54,2	24

It complies with the requirements of the safety standards UNI-EN ISO 4414: 2011: Protection against accidental tearing of the tube during decompression and "whiplash" effect.

FLUID-10S-H

Safety female quick coupler BSPP

SAFETY

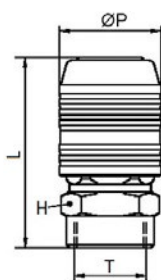

CODE	T	ØP	L	H
FLUID-10S-H1/4	G 1/4"	26,6	53,7	19
FLUID-10S-H3/8	G 3/8"	26,6	55,2	22
FLUID-10S-H1/2	G 1/2"	26,6	59,4	25

It complies with the requirements of the safety standards UNI-EN ISO 4414: 2011: Protection against accidental tearing of the tube during decompression and "whiplash" effect.

FLUID-10S-E

Safety quick coupler with barb connector

SAFETY

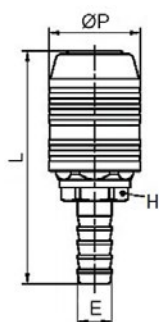

CODE	E	ØP	L	H
FLUID-10S-E6	7,2	26,6	63,2	19
FLUID-10S-E8	9,2	26,6	63,2	19
FLUID-10S-E10	11,2	26,6	67,2	19
FLUID-10S-E12	13,2	26,6	72,2	19
FLUID-10S-E13	13,8	26,6	72,2	19

It complies with the requirements of the safety standards UNI-EN ISO 4414: 2011: Protection against accidental tearing of the tube during decompression and "whiplash" effect.



FLUID-10S-PM

Safety joint push-on fitting

SAFETY

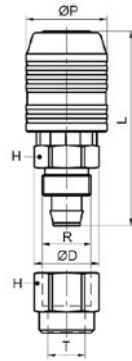

CODE	Ø TUBE	R	ØP	L	H	H1
FLUID-10S-PM08	8x12	M16x1	26,6	64,7	19	19
FLUID-10S-PM10	10x15	M20x1	26,6	69,5	22	22

To used with PU-PVC tube

It complies with the requirements of the safety standards UNI-EN ISO 4414: 2011: Protection against accidental tearing of the tube during decompression and "whiplash" effect.

NE-10M

Male connection BSPT

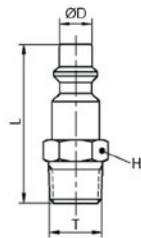

CODE	T	ØD	L	CH
NE-10M	R 1/4"	8	40	14
NE-10M-3/8	R 3/8"	8	42,5	17
NE-10M-1/2	R 1/2"	8	46	22

NE-10H

Female connection BSPP

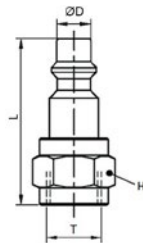

CODE	T	ØD	L	H
NE-10H	G 1/4"	8	40	17
NE-10H-3/8	G 3/8"	8	41,5	22
NE-10H-1/2	G 1/2"	8	44	25

NE-10E

Connection with barb connector

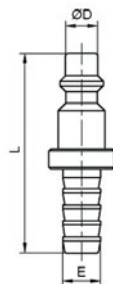

CODE	E	ØD	L	H
NE-10E-6	7,2	8	46	14
NE-10E-8	9,2	8	47	14
NE-10E-10	11,2	8	52	14
NE-10E-12	13,2	8	54	14



NE-10PM

Connection with push-on fitting

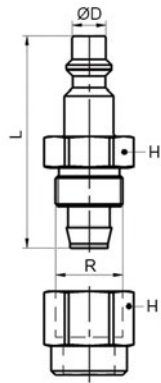

CODE	Ø TUBE	R	ØD	L	H
NE-10PM-08	8x12	M16x1	8	50,7	19
NE-10PM-10	10x15	M20x1	8	55,5	22

To used with PU-PVC tube



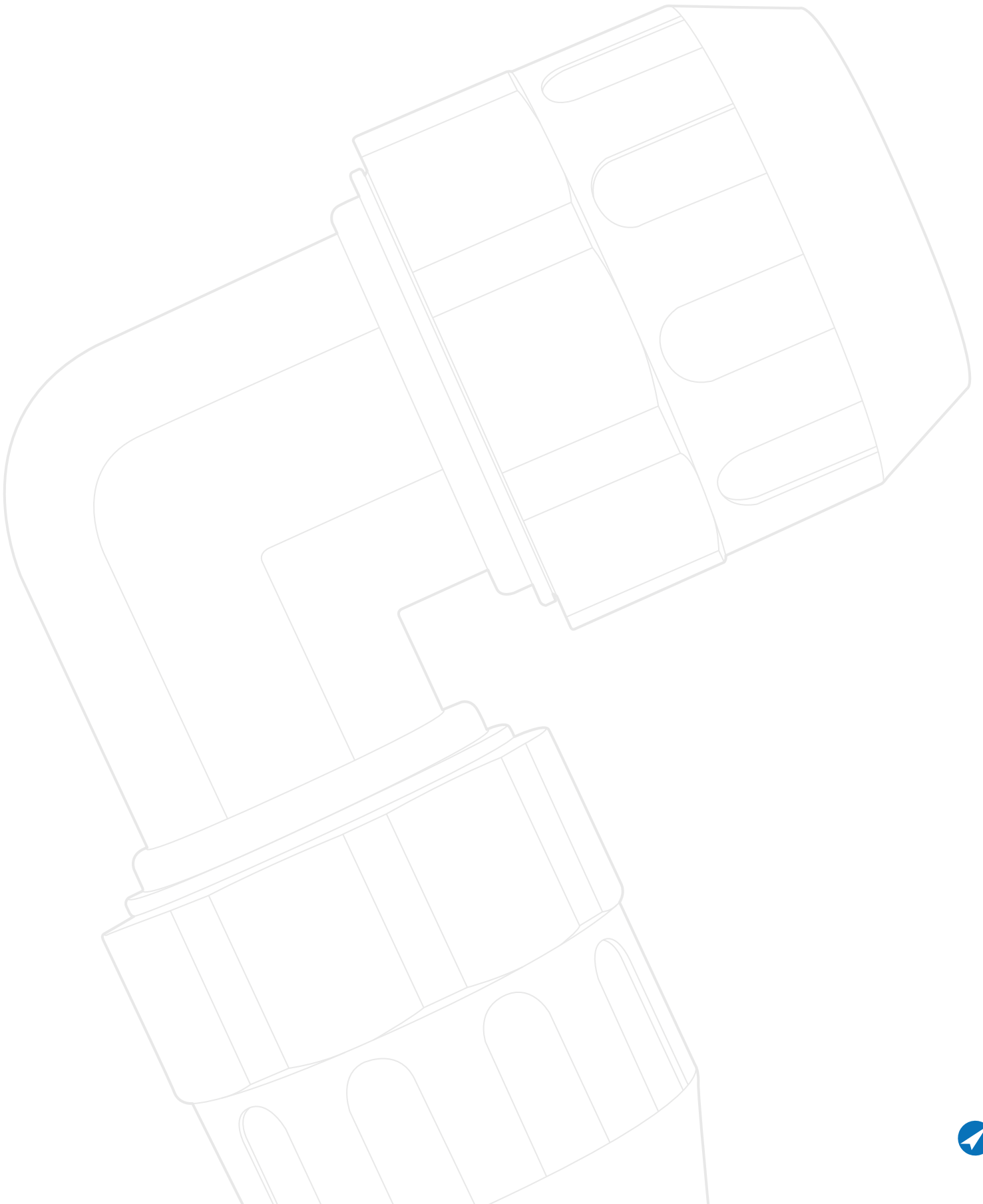

EUROSTANDARD - GERMANY PROFILE

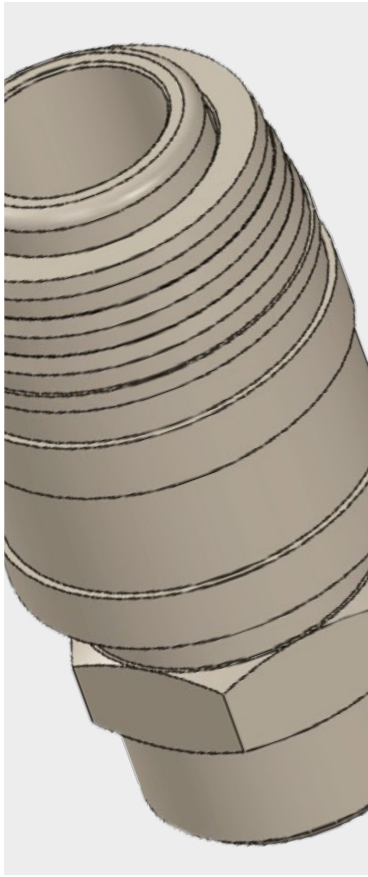

-10°C ÷ +95°C



Working pressure

EU-75N:

0-12 Bar (suggest)

35 Bar (max.)

EU-75S:

0-7 Bar (suggest)



Compressed air



DN 7,6 mm



- Taper gas BSPT ISO 7
from R 1/4" to R 1/2"

- Parallel gas BSPP ISO 228
from G 1/4" to G 1/2"

FLOW

1125 l/min (EU-75N)

542 l/min (EU-75S - SAFETY)

CONFIGURATIONS

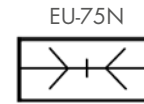

PL
Free
Passage

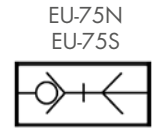

SO
Single
Shutter



Products in compliance with
EC Regulation 1907/2006



Products in compliance with
the directive EU 2015/863



COMPONENTS	EU-75N	EU-75S
Body	Nickel plated steel	Nickel plated steel
Adapter	Nickel plated brass	Nickel plated brass
Slide	Nickel plated steel	Nickel plated steel
Valve	Nickel plated brass	Nickel plated brass
Spring	Stainless steel AISI 302	Stainless steel AISI 302
Ball	Chrome steel	Chrome steel
Retaining ring	Stainless steel AISI 302	Stainless steel AISI 302
External cartridges	-	Nickel plated steel
Seal	NBR	NBR

CONNECTION	AEU-75
Body	Nickel plated steel

FLOW DROP EUROSTANDARD

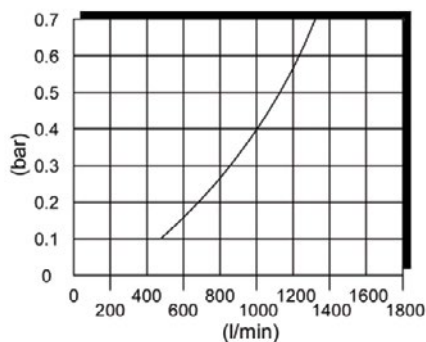

FLOW DROP EUROSTANDARD SAFETY

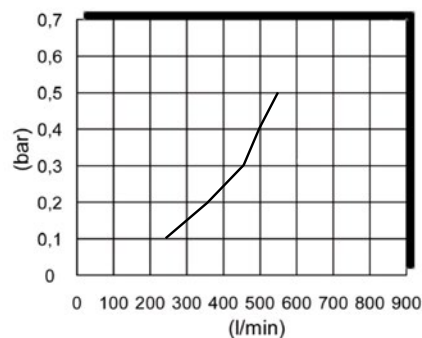

All charts have been created considering a pressure of 6 Bar with low drop of 0.5 Bar and simple lock

EU-75N-M

Male quick coupler BSPT thread

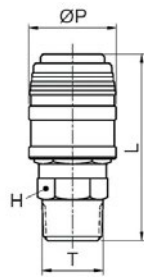

CODE	T	ØP	L	H
EU-75N-M1/4	R 1/4"	24,4	51,7	19
EU-75N-M1/4-PL	R 1/4"	24,4	51,7	19
EU-75N-M3/8	R 3/8"	24,4	52,7	19
EU-75N-M3/8-PL	R 3/8"	24,4	52,7	19
EU-75N-M1/2	R 1/2"	24,4	57,2	22
EU-75N-M1/2-PL	R 1/2"	24,4	57,2	22

MALE QUICK COUPLER BSPP THREAD

EU-75N-M1/4G	G 1/4"	24,4	50,2	21
EU-75N-M1/4G-PL	G 1/4"	24,4	50,2	21
EU-75N-M3/8G	G 3/8"	24,4	51,7	21
EU-75N-M3/8G-PL	G 3/8"	24,4	51,7	21
EU-75N-M1/2G	G 1/2"	24,4	54,7	24
EU-75N-M1/2G-PL	G 1/2"	24,4	54,7	24

-PL: Free passage

EU-75N-H

Female quick coupler BSPP thread

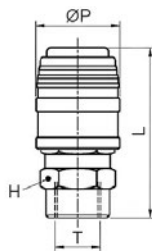

CODE	T	ØP	L	H
EU-75N-H1/4	G 1/4"	24,4	49,7	19
EU-75N-H1/4-PL	G 1/4"	24,4	49,7	19
EU-75N-H3/8	G 3/8"	24,4	51,2	22
EU-75N-H3/8-PL	G 3/8"	24,4	51,2	22
EU-75N-H1/2	G 1/2"	24,4	55,4	25
EU-75N-H1/2-PL	G 1/2"	24,4	55,4	25

-PL: Free passage

EU-75N-E

Quick coupler with barb connector

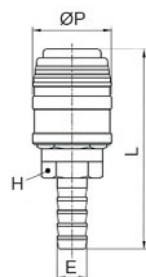

CODE	E	ØP	L	H
EU-75N-E6	7,2	24,4	59,2	19
EU-75N-E6-PL	7,2	24,4	59,2	19
EU-75N-E8	9,2	24,4	59,2	19
EU-75N-E8-PL	9,2	24,4	59,2	19
EU-75N-E10	11,2	24,4	63,2	19
EU-75N-E10-PL	11,2	24,4	63,2	19
EU-75N-E12	13,2	24,4	68,2	19
EU-75N-E12-PL	13,2	24,4	68,2	19
EU-75N-E13	13,8	24,4	68,2	19
EU-75N-E13-PL	13,8	24,4	68,2	19

-PL: Free passage



EU-75N-PM

Joint push-on fitting

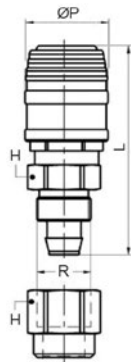

CODE	Ø TUBE	R	ØP	L	H
EU-75N-PM08	8x12	M16x1	24,4	61,9	19
EU-75N-PM08-PL	8x12	M16x1	24,4	61,9	19
EU-75N-PM10	10x15	M20x1	24,4	62,6	22
EU-75N-PM10-PL	10x15	M20x1	24,4	62,6	22

To used with PU-PVC tube

-PL: Free passage

EU-75S-M

Safety male quick coupler BSPT thread

SAFETY

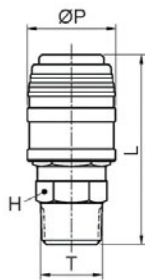

CODE	T	ØP	L	H
EU-75S-M1/4	R 1/4"	28,5	53,6	19
EU-75S-M3/8	R 3/8"	28,5	54,6	19
EU-75S-M1/2	R 1/2"	28,5	59,1	22

SAFETY MALE QUICK COUPLER BSPP THREAD

EU-75S-M1/4G	G 1/4"	28,5	52,1	21
EU-75S-M3/8G	G 3/8"	28,5	53,6	21
EU-75S-M1/2G	G 1/2"	28,5	54,7	24

It complies with the requirements of the safety standards UNI-EN ISO 4414: 2011: Protection against accidental tearing of the tube during decompression and "whiplash" effect.

EU-75S-H

Safety female quick coupler BSPP thread

SAFETY

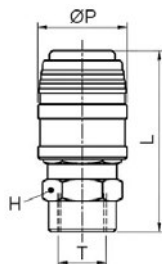

CODE	T	ØP	L	H
EU-75S-H1/4	G 1/4"	28,5	51,6	19
EU-75S-H3/8	G 3/8"	28,5	53,1	22
EU-75S-H1/2	G 1/2"	28,5	57,3	25

It complies with the requirements of the safety standards UNI-EN ISO 4414: 2011: Protection against accidental tearing of the tube during decompression and "whiplash" effect.



EU-75S-E

Safety quick coupler with barb connector

SAFETY

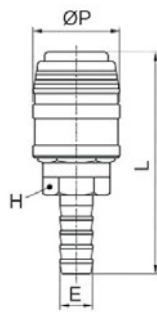

CODE	E	ØP	L	H
EU-75S-E6	7,2	28,5	61,1	19
EU-75S-E8	9,2	28,5	61,1	19
EU-75S-E10	11,2	28,5	65,1	19
EU-75S-E12	13,2	28,5	70,1	19
EU-75S-E13	13,8	28,5	70,1	19

It complies with the requirements of the safety standards UNI-EN ISO 4414: 2011: Protection against accidental tearing of the tube during decompression and "whiplash" effect.

EU-75S-PM

Joint push-on fitting

SAFETY

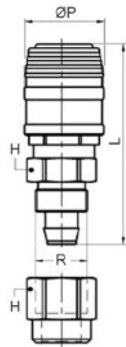

CODE	Ø TUBE	R	ØP	L	H
EU-75S-PM08	8x12	M16x1	28,5	65,2	19
EU-75S-PM10	10x15	M20x1	28,5	70	22

To used with PU-PVC tube

It complies with the requirements of the safety standards UNI-EN ISO 4414: 2011: Protection against accidental tearing of the tube during decompression and "whiplash" effect.

AEU-75M

Male connection BSPT thread

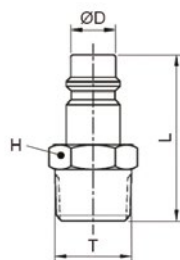

CODE	T	ØD	L	H
AEU-75M	R 1/4"	10	36,5	14
AEU-75M38	R 3/8"	10	37	17



AEU-75H

Female connection BSPP thread

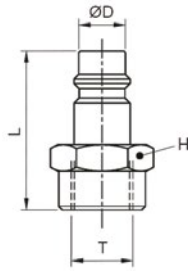

CODE	T	ØD	L	H
AEU-75H	G 1/4"	10	34	17
AEU-75H38	G 3/8"	10	34,5	20

AEU-75E

Connection with barb connector

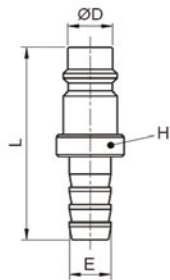

CODE	E	ØD	L	H
AEU-75E	9,2	10	44	15
AEU-75E10	11,2	10	48	15

AEU-75PM

Connection with push-on fitting

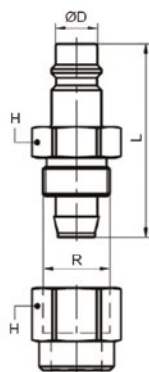

CODE	Ø TUBE	R	ØD	L	CH
AEU-75PM08	8x12	M16x1	10	46,7	19
AEU-75PM10	10x15	M20x1	10	51,5	22

To used with PU-PVC tube



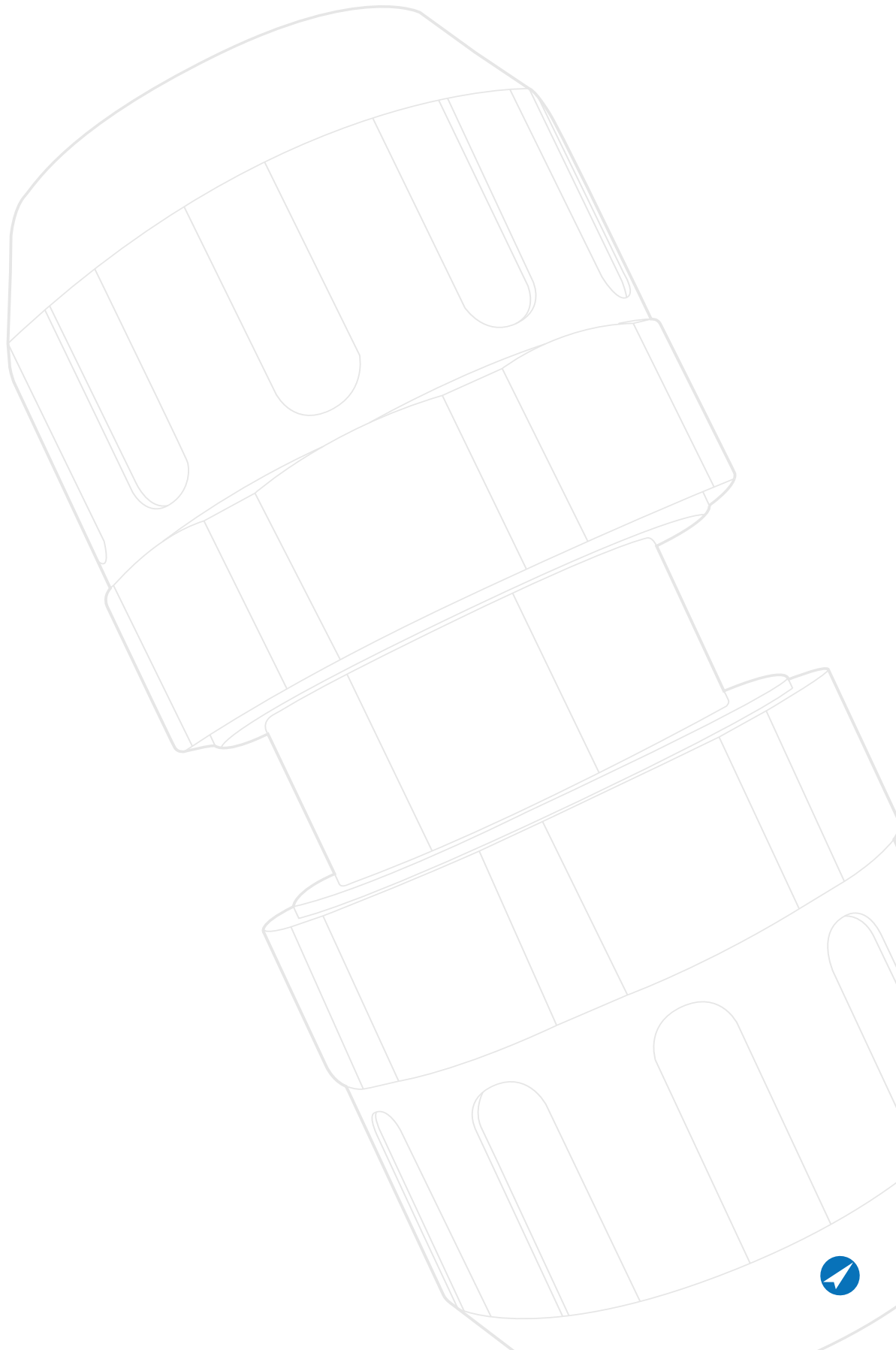



-20°C ÷ +60°C



Working Pressure:

20 Bar

Bursting Pressure:

60 Bar



Compressed air, vacuum
and fluids suitable with the
construction materials



Inner layer: Transparent PVC in a
special blend

Reinforcement: Synthetic textile insert

Outer layer: PVC with polyurethane

SILICONE FREE



Products in compliance with
EC Regulation 1907/2006

RoHS3

Products in compliance with
the directive EU 2015/863

PU-PVC

Light blue polyurethane tube with non-toxic PVC inner layer



CODE	Ø IDxOD	THICKNESS (mm)	MIN. BENDING RADIUS (mm)	WORKING PRESSURE (Bar)	BURSTING PRESSURE (Bar)	g/m	Q.TY FOR ROLL (mt)
PU-PVC0610AZ	6x10	2	55	20	60	65	100
* PU-PVC0812AZ	8x12	2	65	20	60	80	100
* PU-PVC1015AZ	10x15	2,5	68	20	60	100	100
PU-PVC1016AZ	10x16	3	70	20	60	155	100
PU-PVC1319AZ	13x19	3	105	20	60	180	100

* Sizes suitable for use with FLUID-10N-PM, FLUID-10S-PM, NE-10PM, EU-75M-PM, EU-75S-PM and AEU-75-PM



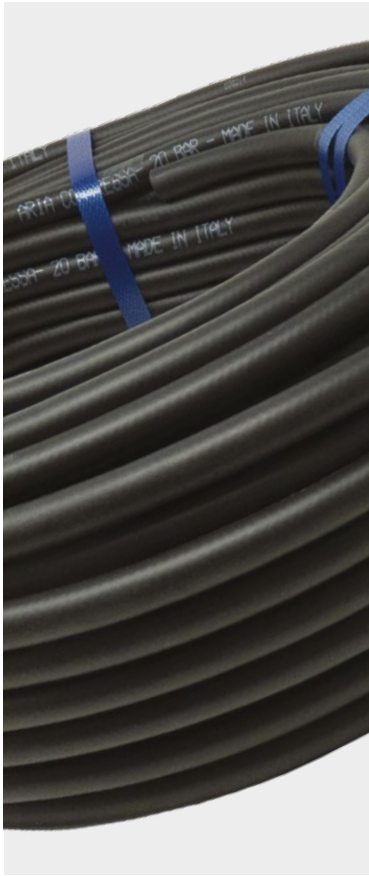

-20°C ÷ +60°C



Working Pressure:

20 Bar

Bursting Pressure:

60 Bar



Compressed air, vacuum and fluids suitable with the construction materials



Inner layer: PVC in a special blend

Reinforcement: Synthetic polyester textile insert

Outer layer: PVC

SILICONE FREE



Products in compliance with EC Regulation 1907/2006



Products in compliance with the directive EU 2015/863

PVC-AC

Black PVC tube with reinforcement in polyester fiber



CODE	Ø IDxOD	THICKNESS (mm)	MIN. BENDING RADIUS (mm)	WORKING PRESSURE (Bar)	BURSTING PRESSURE (Bar)	g/m	Q.TY FOR ROLL (mt)
PVC-AC0614NE100	6x14	4	25	20	60	170	100
PVC-AC0817NE100	8x17	4,5	30	20	60	240	100
PVC-AC1019NE100	10x19	4,5	32	20	60	280	100
PVC-AC1323NE	13x23	5	40	20	60	390	50
PVC-AC1928NE	19x28	4,5	60	20	60	550	50



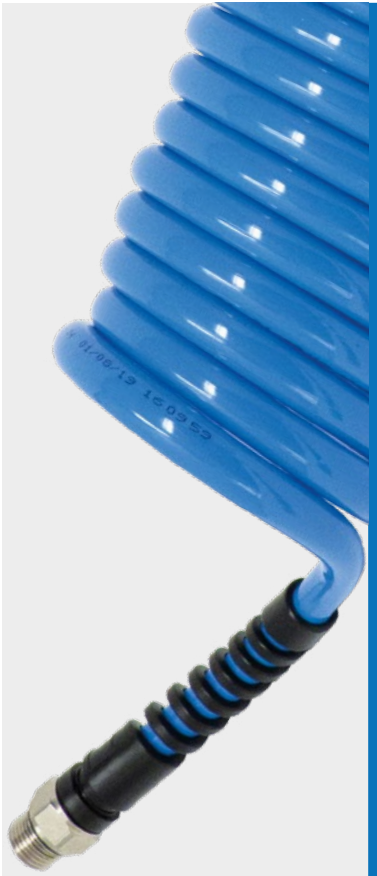

-40°C ÷ +60°C



Working Pressure:

See the table

Negative Pressure:

-0,95 Bar (- 95 kPa)



Compressed air



Parallel gas BSPP ISO 228
G 1/4" and G 3/8"



Tube: Polyurethane on polyester
basis

Fittings: Nickel plated brass
(UCES-G)

FEATURES

Very flexible tubing with good elastic properties even at low temperatures. Good chemical, abrasion and ageing resistance. If exposed to sunlight, color may change slightly but mechanical features remain unchanged.

Hardness: Shore 98 A

Ultimate tensile strength: 50 MPa

Ultimate tensile strain: 400%

Specific weight: 1,23 g/cc

Ultimate shear strength: 123 N/mm

Abrasion resistance: 30 mm³



Products in compliance with
EC Regulation 1907/2006



Products in compliance with
the directive EU 2015/863

WORKING PRESSURE EXPRESSED IN % AS A FUNCTION OF TEMPERATURES

20°C	30°C	40°C	50°C	60°C
100%	83%	72%	64%	47%



UCES

PU coiled tube on polyester basis

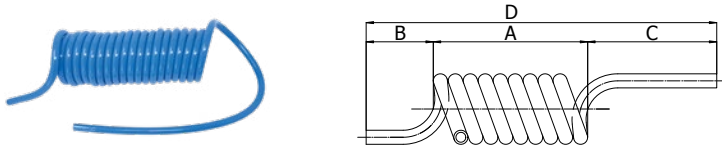

CODE	Ø ODxID	A (mm)	B (mm)	C (mm)	D (mm)	WORKING PRESSURE AT 23 °C (Bar)	BURSTING PRESSURE AT 23 °C (Bar)	LEGHT TUBE (m)	NUMBER OF TURNS	Ø INTERNAL COILED TUBE (mm)	WEIGHT (g)
UCES060435	6x4	134	100	500	734	12	40	3,5	31	30	85
UCES060405		266	100	500	866	12	40	5,0	44	30	110
UCES060475		399	100	500	999	12	40	7,5	66	30	165
UCES060410		532	100	500	1132	12	40	10,0	88	30	215
UCES080535	8x5	194	100	500	794	14	45	3,5	34	25	155
UCES080505		387	100	500	987	14	45	5,0	48	25	205
UCES080575		580	100	500	1180	14	45	7,5	72	25	300
UCES080510		773	100	500	1373	14	45	10,0	97	25	395
UCES106505	10x6,5	399	100	500	999	13	42	5,0	40	30	315
UCES106575		598	100	500	1198	13	42	7,5	60	30	455
UCES106510		797	100	500	1397	13	42	10,0	80	30	600
UCES120805	12x8	266	100	500	866	12	40	5,0	22	60	455
UCES120875		399	100	500	999	12	40	7,5	33	60	660
UCES120810		532	100	500	1132	12	40	10,0	44	60	860

Sizes Ø ODxID	● Light blue	● Yellow
	6x4	UCES060435AZ
UCES060405AZ		UCES060405GL
UCES060475AZ		UCES060475GL
UCES060410AZ		UCES060410GL
8x5	UCES080535AZ	UCES080535GL
	UCES080505AZ	UCES080505GL
	UCES080575AZ	UCES080575GL
	UCES080510AZ	UCES080510GL
10x6,5	UCES106505AZ	UCES106505GL
	UCES106575AZ	UCES106575GL
	UCES106510AZ	UCES106510GL
12x8	UCES120805AZ	UCES120805GL
	UCES120875AZ	UCES120875GL
	UCES120810AZ	UCES120810GL



UCES-G

PU coiled tube on polyester basis with spring & BSPP thread fittings

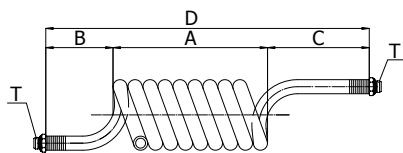

CODE	Ø ODxID	T	A (mm)	B (mm)	C (mm)	D (mm)	WORKING PRESSURE AT 23 °C (Bar)	BURSTING PRESSURE AT 23 °C (Bar)	LENGHT TUBE (m)	NUMBER OF TURNS	Ø INTERNAL COILED TUBE (mm)	WEIGHT (g)
* UCES060435G14	6x4	2x G 1/4"	134	100	500	734	12	40	3,5	31	30	165
* UCES060405G14		2x G 1/4"	266	100	500	866	12	40	5,0	44	30	190
* UCES060475G14		2x G 1/4"	399	100	500	999	12	40	7,5	66	30	240
* UCES060410G14		2x G 1/4"	532	100	500	1132	12	40	10,0	88	30	290
UCES080535G14	8x5	2x G 1/4"	194	100	500	794	14	45	3,5	34	25	230
UCES080505G14		2x G 1/4"	387	100	500	987	14	45	5,0	48	25	280
UCES080575G14		2x G 1/4"	580	100	500	1180	14	45	7,5	72	25	375
UCES080510G14		2x G 1/4"	773	100	500	1373	14	45	10,0	97	25	470
UCES106505G14	10x6,5	2x G 1/4"	399	100	500	999	13	42	5,0	40	30	385
UCES106575G14		2x G 1/4"	598	100	500	1198	13	42	7,5	60	30	525
UCES106510G14		2x G 1/4"	797	100	500	1397	13	42	10,0	80	30	670
UCES120805G38	12x8	2x G 3/8"	266	100	500	866	12	40	5,0	22	60	550
UCES120875G38		2x G 3/8"	399	100	500	999	12	40	7,5	33	60	755
UCES120810G38		2x G 3/8"	532	100	500	1132	12	40	10,0	44	60	955

* Ø 6x4 fittings are in yellow brass

Sizes Ø ODxID	● Light blue	● Yellow
	6x4	UCES060435G14AZ
	UCES060405G14AZ	UCES060405G14GL
	UCES060475G14AZ	UCES060475G14GL
	UCES060410G14AZ	UCES060410G14GL
8x5	UCES080535G14AZ	UCES080535G14GL
	UCES080505G14AZ	UCES080505G14GL
	UCES080575G14AZ	UCES080575G14GL
	UCES080510G14AZ	UCES080510G14GL
10x6,5	UCES106505G14AZ	UCES106505G14GL
	UCES106575G14AZ	UCES106575G14GL
	UCES106510G14AZ	UCES106510G14GL
12x8	UCES120805G38AZ	UCES120805G38GL
	UCES120875G38AZ	UCES120875G38GL
	UCES120810G38AZ	UCES120810G38GL



PED DECLARATION

* Declaration available on our website (www.f-linepro.it) or on request.



Tierre Group S.p.a.
Headquarter: Via Dell'Industria 18 – 20032 Cormano (MI) – Italy
Warehouse: Via Dell'Artigianato 2 – 20032 Cormano (MI) – Italy
Production: Via Marco Biagi 1 – 25045 Castegnato (BS) – Italy
C.F. e P.IVA IT 12437570158 – Capital €120.000,00 i.v.
REA MI-1558390

Phone. +39 02 663088.1 – Fax +39 02 66304172
www.tierregroup.com – info@tierregroup.com

DECLARATION OF CONFORMITY**PED****Pressure Equipment Devices**

In compliance with the Directive **2014/68/EU (PED)** of the European Parliament and of the Council of 15th May 2014

TIERRE GROUP S.p.a.**DECLARES**

that the products of the *F-Line.PRO* series, diameters 20mm, 25mm and 40mm, with a maximum PN 16 bar, are classified in the category as referred in Article 4 paragraph 3. The products are designed and manufactured according to correct construction practices, and must not bear the CE marking, as stated in article 18 of the same Directive.

Cormano, 23rd march 2022

TIERRE GROUP S.p.a.
Dott. Marco Regis

PED

M2DC rev.0 – Gennaio 2020







www.f-linepro.it info@tierregroup.com



Tierre Group S.p.a.

via dell'Industria, 18 - 20032 Cormano (MI)

Tel. +39 02 663088.1 - Fax +39 02 66304172

www.tierregroup.com - info@tierregroup.com

C.F. e P.IVA 12437570158

Cap. Soc. Euro 120.000,00 i.v. - REA MI-1558390

F-Line.PRO Catalogue - Ed. 2.1 - 03/23